

**BHARAT HEAVY ELECTRICALS LIMITED**

[A Government of India Undertaking]

Ramachandrapuram, Hyderabad, 502032, A.P. India
Phone 040-23184526, 23182322 FAX:040-23021910, 1954**भारत हेवी इलेक्ट्रिकल्स लिमिटेड**

(भारत सरकार का उपक्रम)

रामचन्द्रपुरम, हैदराबाद, 502032 आंध्र प्रदेश, भारत

RFQ NO :

PURCHASE DEPARTMENT**ENQUIRY****क्रय विभाग**

जांच (ई मेल : tenderbox@bhelhyd.co.in)

SHEET:1
OF :1HY17001 C
REV.NO.0Phone 091-40-23184526
091-40-23182322FAX : 091-40-23021910
091-40-23021954**PURCHASE DEPARTMENT**

GSTIN:

Enq/Collective No :D3A1X20421

Enq.Dt. : 20.01.2024

No.Of Items :1

DUE Dt. OF QUOTN. : 17.02.2024

Office Copy

Please submit your lowest quotation in sealed cover superscribed with Enquiry No./Collective No.(RFQ No) and due date subject to our terms and conditions attached ,for the materials mentioned below. Your offer has to reach us on or before due date by 11.00 Hours (IST) and will be opened at 14.00 Hours.(IST).If our Enquiry No./Collective No.(RFQ No) and tender due date are not super scribed on the tender cover , your offer shall be summarily rejected. Incomplete offers and late offers will not be considered.

SL NO	Purchase Req.no	item no	Material Code, HSN No.	Drg no - Ver , Rev & Spec - Ver , Rev,Spec-Var	Description	Unit	Qty	Delivery Date	Schedule Qty
1	8000120421	10	HE9751544009 8108	NA-,,HE51544,02,	SMLS TITANIUM TUBE DIA 15.875X0.7X4500	EA	8,800.000	24.12.2024	8,800.000

Special Remarks

CheckList of Quality Interventions:

BHEL reserves the right to enforce any or all of the following checks during execution of the order.
There is no additional cost to the vendor on account of these checks.

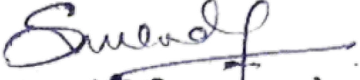
అ సురేందర్
A SURENDER

TEST CERTIFICATE REQD:
 GUARANTEE REQ :
 SAMPLE REQD :
 BID TYPE : TWO PART

ప్రबंधక / క్రయ - ఎంపిక కోసం
 Bharat Heavy Electricals Limited.
 వీ.ఎచ్.ఇ.ఎల్.-ఎచ్.పీ.ఇ.పీ, హైదరాబాద్ 32. BHEL-HPEP, HYD-32
 A SURENDER
 MANAGEER/PUR(HE&F)



**SPECIAL CONTRACT CONDITIONS FOR
ENQUIRY NO. D3A1X20421 DATED 20.01.2024**

S. NO.	ITB Clause No.	TERMS & CONDITIONS	BHEL REQUIREMENT				VENDOR 'S CONFIRMATION
I TECHNICAL TERMS							
1		Description, Size and Quantity	Item No.	Material Code	Description	Total Quantity	
			1	HE9751544009	SMLS TITANIUM TUBE DIA 15.875X0.7X4500	8800	
2		Specification	All clauses of HE51544 Rev.02 are to be strictly adhered.				
3		Material	Tubes shall be seamless and shall confirm to SB338 Gr.2 of ASME Sec-II Part-B 2021 Edition.				
4		Quality Plan	All quality requirements and certifications shall be as per QAP HYQA/VSQP/2017-18/HE/115.1032006900/S5 Rev.01.				
5		TESTING	Each tube shall be Eddy Current tested as per Clause No.12.1 of HE51544 Rev.02.				
			Each tube shall be Ultrasonic Tested (UT) as per Clause No.12.2 of HE51544 Rev.02.				
			Each tube shall be Hydro tested at 70 Kg/Sq.cm(g) as per Clause No. 12.3 of HE51544 Rev.02.				
6		Packing & Marking	As per BHEL Standard AA0490002 Rev.02. <u>Note:</u> Packing shall be seaworthy for Foreign consignments.				
7		Raw Material	Raw Materials required for manufacturing of tubes shall not be manufactured from melted out scrap titanium material.				
8	36	Inspection & Certification	For Indian Vendors: By BHEL TPIA as per Quality Plan. Note: a) Vendors are advised to raise Inspection Call in CQIR system (www.cqir.bhel.in) with Purchasing Unit as 'HPEP' at least '7' days prior to the proposed date of inspection.				
			For Foreign Bidders: By Lloyd's/TUV/BV/DNV (Overseas Inspection Agency) as per Quality Plan.				
II COMMERCIAL TERMS							
1	3	Mode of Submission	Conventional mode and offers shall be submitted as mentioned at Cl.No.5.B(i) of ITB. Note: Offer shall be submitted in two part bid system Part-1 (i.e, Techno-Commercial bid including Pre-Qualification) and Part-2 (Price Bid) separately in two sealed covers indicating our enquiry No. D3A1X20421, date and tender due date clearly.				
2	6	Indigenous Purchase - Destination	BHEL RC Puram, Hyderabad				
		Imports Purchase - Destination	Mumbai Sea Port for Foreign vendors Freight & Insurance up to Mumbai Sea Port is in vendor scope.				
3		Basic Custom Duty	Merit Duty				
4		Third Party Inspection Charges	For Indian Bidders: By BHEL and vendor's offer will be loaded by appropriate percentage for evaluation of offers. Currently it is 0.198%.				
			For Foreign Bidders: Shall be inclusive in quoted price.				
5	10	Price Validity	90 Days from Part-I bid opening date.				
6	12	Tender Cost	Not Applicable.				
7		Earnst Money Deposit	Not Applicable.				
8	8	Delivery	8 Months from PO date.				
			Note: For any deviation in delivery period as indicated above, quoted price shall be loaded by 0.5% per week for evaluation of offer. However, BHEL reserves the right to reject the offers with delivery period not meeting the project requirement.				

S. NO.	ITB Clause No.	TERMS & CONDITIONS	BHEL REQUIREMENT	VENDOR 'S CONFIRMATION
9	5	Type of bid	Offer shall be submitted in 2-Part bid with Part-1 consists of Techno-commercial bid (SCC, ITB, PQC and all other supporting documents mentioned therein) and Part-2 consists of Price bid. Note: Pre-Qualification Criteria is part of techno-commercial bid. BHEL prefers to evaluate Pre-Qualification Criteria of vendors first and rest of the techno-commercial bid subsequently. However, at its discretion BHEL may evaluate both Technical and Pre-Qualification Criteria simultaneously.	
10		Techno-Commercial Bid	Techno-Commercial Bid shall essentially consist of: (i) Duly filled in signed and stamped Special Contract Conditions (SCC). (ii) Duly filled in signed and stamped Instructions to Bidder (ITB) along with Annexure-I, II, III, IV. (iii) Duly filled in signed and stamped Pre-Qualification Criteria (PQC) along with its Annexure and supporting documents for qualification. (iv) Udyam Registration Certificate for MSE vendors (v) Documents/declarations in compliance with Annexure-A,B (if applicable) (vi) Duly filled in signed and stamped Integrity Pact. Note: Bid shall be complete in all respects including all the documents / information required for techno-commercial evaluation. Incomplete offers shall be liable to rejection.	
11		Price Bid	Quoted price shall be on firm basis. Vendor shall quote on Rate / Tube basis.	
12	9	Price Variation Clause	Not Applicable.	
13	Others	Quantity Split	Not Splittable.	
14		Purchase Preference to MSE/MII Vendors	Purchase Preference shall be in line with Order No. F.1/4/2021-PPD Dated 18.05.2023 issued by Ministry of Finance.	
15	Others	Contract Execution Bank Guarantee	Not Applicable.	
16	17	Performance Bank Guarantee	Not Applicable.	
17	7	Additional Documentation for Payment	- MTC, CQIR along with Internal TCs as per QAP. - Guarantee Certificate	
18	13	Maximum Penalty Applicable on	Delayed Portion Value.	
19	Others	Contract Specific Penalty Clause (Indigenous Purchase)	C-Note Date or Date of submission of documents whichever is later shall be considered as delivery date incase documents are not submitted within 10 days from the dispatch of the material.	
20	16	Guarantee	Guarantee on the supplies for a period of 18 months from the date of dispatch or 12 months from the date of commissioning whichever is earlier.	
21		Reverse Auction	BHEL shall be resorting to Reverse Auction (RA) (Guidelines as available on www.bhel.com) for this tender. RA shall be conducted among the techno-commercially qualified bidders. Price bids of all techno-commercially qualified bidders shall be opened and same shall be considered for RA. In case any bidder(s) do(es) not participate in online Reverse Auction, their sealed envelope price bid along with applicable loading, if any, shall be considered for ranking. RA representative details like Name, e-mail, Phone No. etc.	



**SPECIAL CONTRACT CONDITIONS FOR
ENQUIRY NO. D3A1X20421 DATED 20.01.2024**

S. NO.	ITB Clause No.	TERMS & CONDITIONS	BHEL REQUIREMENT	VENDOR 'S CONFIRMATION
22		Integrity Pact	<p>(a) IP is a tool to ensure that activities and transactions between the Company and its Bidders / Contractors are handled in a fair, transparent and corruption free manner. A panel of Independent External Monitors (IEMs) have been appointed to oversee implementation of IP in BHEL. <u>Details of IEM for this tender is furnished below:</u> Name : Shri Otem Dai, IAS (Retd.), e-Mail : iem1@bhel.in Name : Shri Bishwamitra Pandey, IRAS (Retd.) e-Mail : iem2@bhel.in Name : Shri Mukesh Mittal, IRS (Retd.) e-Mail : iem3@bhel.in</p> <p>(b) The IP as enclosed with the tender is to be submitted (duly signed by authorized signatory who signs in the offer) along with techno-commercial bid. Only those bidders who have entered into such an IP with BHEL would be competent to participate in the bidding. In other words, entering into the Pact would be a preliminary qualification.</p> <p>(c) Please refer Section-8 of the IP for the Role and Responsibilities of IEMs. In case of any complaint arising out of the tendering process, the matter may be referred to the IEM mentioned in the tender.</p>	
			<p>Note: No routine correspondence shall be addressed to the IEM (phone / post / email) regarding the clarifications, time extensions or any other administrative queries, etc. on the tender issued. All such clarifications / issues shall be addressed directly to the tender issuing (procurement) department.</p>	
23		Terms & Conditions	<p>Vendor is requested to furnish all details of the offer in SCC and ITB. In case of any discrepancy between information furnished in these documents and those furnished elsewhere in the bid, the information furnished in these documents only shall be considered, and those furnished else where shall be ignored.</p> <p>In case vendor response is 'NOTED/OK' against any clause in documents like PQC, SCC, ITB. The same shall be treated as CONFIRMED for that particular clause.</p>	
24	Others	Financial / Commercial PQC	<p>Applicable</p> <p>The minimum average Financial turnover of the supplier during last 3 financial years should not be less than Rs.1.1 Crs and positive net worth as per latest Balance sheet.</p> <p>Vendor shall submit last three years Audited Financial statements of Balance sheet & Profit & Loss statement</p>	

PRE-QUALIFICATION CRITERIA (PQC)				
Seamless Titanium tubes for Steam Surface condenser / Heat Exchangers				
Ref No.	HE-HEC-PQC-TISLTB	REV.01 Dt.03.01.2024	Enq No:	
S.No.	BHEL Requirement	Supplier Confirmation	Deviation If Any	Remarks.
1	All the suppliers need to submit this document i.e. titled pre-qualification criteria and furnish required information along with offer.			
a)	Name, address, e-mail id, contact no.etc. of manufacturing mill for Seamless Titanium tubes.			
b)	Name, address, e-mail id, contact no.etc. of authorised agency / trading house quoting on behalf of manufacturing mill. In case offer is received from authorised agency / trading house, the following requirements shall be fulfilled.			
i)	Valid letter of authorisation and copy of agreement to be enclosed with offer.			
ii)	The offer shall be either from the authorised agency or from the manufacturer directly. In case of BHEL receiving offer from both, then offer from manufacturer will only be considered. Offer from an unauthorised agency / entity on behalf of any vendor shall be summarily rejected.			
iii)	Name, address, e-mail id, contact no.etc. of entity on whom order to be released in case of L1 shall be clearly indicated.			
2	Supplier to confirm the following criteria and provide necessary documents for evaluation of offer.			
(a)	The supplier shall have proven experience in manufacturing and supply of Seamless Titanium tubes for Steam Surface Condensers or Heat Exchangers as mentioned below.			
i)	Material : SB 338 Gr2 (Seamless)			
ii)	Tube O.D. : Dia.15.875mm or higher			
iii)	Tube Length : Minimum 1500 mm			
iv)	Tube Thickness : Minimum 0.5mm or thicker			
v)	Minimum tonnage supplied : 1000 kgs			
vi)	Application : Steam Surface Condensers or Heat Exchangers with seawater flowing through tubes.			
vii)	Satisfactory Working of Equipment: The exchanger provided with the above tubes with seawater as tube side medium and should have been in service for minimum of ONE year prior to the date of techno commercial bid opening.			
viii)	The supplier should preferably be an original Seamless Titanium tube manufacturer. All the facilities required for manufacturing Seamless titanium tubes should be available with the tube manufacturer. a) Seamless cold drawing facility of tubes from mother hollows. b) Annealing facility (At applicable temperature range of 550 to 600 deg. C), c) Online or offline eddy current testing facility, d) Ultrasonic test facility, e) Hydrotest Facility			
ix)	All the above criteria [2(a) (i)] to [2(a) (viii)] must be combinedly met by the supplier against a single supply reference of Surface Condenser or Heat Exchanger with seamless Titanium tubes.			
S.No.	BHEL Requirement	Confirmation	Deviation/Remarks	Deviation/Remarks
2	Supplier's having experience in applications other than Steam Surface Condensers or Heat exchangers will not be treated as a proven experience.			
(b)	The supplier meeting all the above criteria as [2 (a) (i)] to [2 (a) (viii)] shall furnish details including equipment (Steam Surface Condensers or Heat exchangers) Manufacturer's Name, Industry/power plant name, date of supply (in DDMMYY format), No of years the equipment (Steam Surface Condensers or Heat exchangers) is in service, Size of tube(ODxthxL), Quantity and full contact details of equipment (Steam Surface Condensers or Heat exchangers) Manufacturer & end user. (including Mobile no and e-Mail ID) in the enclosed Annexure-I format. OR			
(c)	Heat exchanger manufacturers certificate (in English) containing the supply details as above both 2(a) & 2 (b) Contact details [Land line/ Mobile No.] and complete address of Heat exchanger manufacturer and certifying satisfactory completion of hydrotest. <u>Note</u> : Suppliers shall furnish maximum upto 6 number of latest customer reference details as indicated above in the enclosed Annexure-I format. All the documents shall be furnished only in English. Documents furnished in other			
(d)	BHEL reserves the right to cross verify with the above such customers and satisfy itself with reference to the claims of the supplier. If the information furnished by the supplier is found to be not satisfactory, the offer will be technically rejected.			
3	Offers not fulfilling the requirement as above 2(a) & 2(b) or 2 (c) SHALL not be technically evaluated by BHEL. Further, no correspondence on this matter will be entertained.			
4	For making Seamless Titanium tubes, the mother hollows may be directly procured as raw material or can be made from a round bar by the tube manufacturer. Alternatively, the tube manufacturer can complete the entire process from Ti sponge to Ti tubes in their works, if facilities are available.			

(a)	<p>Tube manufacturer shall furnish the list of suppliers / sources from where Mother hollows / round bars/ Titanium Sponge will be sourced.</p> <p>Details of mother hollow / round bar manufacturing facilities including testing facilities, size ranges and list of the customers to whom they are supplying shall be furnished.</p> <p>This is to review of the credentials of such suppliers and acceptance by BHEL.</p> <p>BHEL also reserves the right to visit such suppliers works for further evaluation if required.</p> <p>Note : In case the tube manufacturer has the facilities either to make mother hollows or round bars at their works, details of the same shall be furnished.</p> <p>The decision of BHEL with regards to list of suppliers to be considered for mother hollows / round bars / Titanium sponge will be final.</p> <p>Acceptance / Rejection of mother hollow / round bar / Ti sponge suppliers does not entertain any claim for revised price bid by the bidder.</p>			
(b)	The mother hollows shall be produced by hot extrusion method only. Any other methods are not acceptable.			
(c)	Tube shall be seamless cold drawn.			
(d)	Either the round bars for making mother hollows or the mother hollows shall be UT tested.			
5	The suppliers shall furnish the detailed process of manufacturing and testing procedures along with the offer.			
6	List of BHEL qualified bidders may be forwarded to BHEL's End Customer for their review and approval. The list finalized by BHEL's End Customer shall be final and binding.			
7	BHEL team may carry out supplier evaluation/assessment by a visit to vendor works. BHEL will accept or reject the technical bid based on the findings of the visit.			
8	Bidders to submit their bid in 2- part system, i.e. Part-I shall consists of Pre-Qualification Criteria along with the required documents and Techno-commercial bids and Part-II shall consists of Price Bid. Offers failing to meet prequalification part will not be considered for further evaluation.			
9	Raw Materials used for manufacturing of tubes like Bars/Billets, Mother Hollows shall not be manufactured from MELTED OUT SCRAP TITANIUM material.			
10	To encourage indigenous supplier inline with "Make in India" initiative by Govt of India, the suppliers who are not having proven experience of meeting the qualification criteria for the present enquiry as indicated above are requested to apply for supplier registration on BHEL portal (www.bhel.com). This will enable BHEL to evaluate the Supplier capability to make the Seamless Titanium tubes for critical applications and to consider for future trial orders.			

ANNEXURE-I

Ref No: HE-HEC-PQC-TISLTB		Steam Surface Condenser or Heat exchanger(HE) Seamless Titanium tube reference details										
Enquiry no.:												
Ref project sl no.	Material SB 338 Gr2 (Seamless)	OD mm (15.875m or higher)	Thk (min 0.5 mm or higher)	Supply date (DDMMYY YY)	Steam Surface Condenser/Heat Exchanger application	Steam Surface Condenser / Heat Exchanger manufacturer details			End customer details			
						Name of Manufacturer	Contact person	E-Mail id & Phone No.	Name of the organisation (Enduser)	Project Details Name: MW Rating: Location:	No.of years the equipment is in service	Contact person
1												
2												
3												
4												
5												
6												

Note:

- a) Reference list shall be submitted in the above format only.
Suppliers are requested to fill the above and submit along with Pre-Qualification Criteria(PQC).
- b) wherever details are not available, supplier to mention as "NA"
- c) Reference project Tube material shall be Seamless Titanium
- d) Reference project Tube OD shall be 15.875 mm (5/8 inch) or higher.
- e) Reference project Tube thickness shall be 0.5 mm or thicker.
- f) Clause no 2(a) (i) to 2(a) (viii) of PQC must be combinedly met by the supplier against a single supply reference of Seamless Titanium tubes. Maximum of 06 such references to be mentioned in the above table

vendor's signature with seal

TD 106-1 Rev No.06	Form No.		PRODUCT STANDARD HYDERABAD		Prod. Std. No. HE51544																		
					REV. NO. 02																		
					PAGE 1 OF 11																		
COPYRIGHT AND CONFIDENTIAL The information on this document is the property of BHARAT HEAVY ELECTRICALS LIMITED. It must not be used directly or indirectly in any way detrimental to the interest of the company.		SEAMLESS TITANIUM TUBES - GRADE 2																					
		1.0 General:																					
		This specification governs the quality of Seamless Titanium Tubes, Grade 2 in annealed condition.																					
		2.0 Application:																					
		For use in surface condensers, evaporators and heat-exchangers.																					
		3.0 Condition of delivery:																					
		Annealed.																					
		4.0 Compliance with standards:																					
		The tubes shall comply with requirements of ASME SB-338 Gr. 2 (Latest applicable code Edition as on the date of enquiry)																					
		5.0 Dimensions & Tolerances:																					
		5.1 Sizes:																					
		The tube shall be supplied as per Outside Diameter (OD), Wall Thickness and Length as specified in the purchase order.																					
		5.2 Tolerances:																					
		5.2.1 On OD and Wall Thickness:																					
		<table border="1" style="width: 100%; border-collapse: collapse;"> <thead> <tr> <th style="text-align: left;">Outside Diameter, mm</th> <th style="text-align: center;">Diameter Tolerances, mm</th> <th style="text-align: center;">Permissible variation in Wall Thickness, percent</th> </tr> </thead> <tbody> <tr> <td>Under 25.4, excl</td> <td style="text-align: center;">± 0.102</td> <td style="text-align: center;">± 10</td> </tr> <tr> <td>25.4 to 38.1, excl</td> <td style="text-align: center;">± 0.127</td> <td style="text-align: center;">± 10</td> </tr> <tr> <td>38.1 to 50.8, excl</td> <td style="text-align: center;">± 0.152</td> <td style="text-align: center;">± 10</td> </tr> <tr> <td>50.8 to 63.5, excl</td> <td style="text-align: center;">± 0.178</td> <td style="text-align: center;">± 10</td> </tr> <tr> <td>63.5 to 88.9, excl</td> <td style="text-align: center;">± 0.254</td> <td style="text-align: center;">± 10</td> </tr> </tbody> </table>				Outside Diameter, mm	Diameter Tolerances, mm	Permissible variation in Wall Thickness, percent	Under 25.4, excl	± 0.102	± 10	25.4 to 38.1, excl	± 0.127	± 10	38.1 to 50.8, excl	± 0.152	± 10	50.8 to 63.5, excl	± 0.178	± 10	63.5 to 88.9, excl	± 0.254	± 10
Outside Diameter, mm	Diameter Tolerances, mm	Permissible variation in Wall Thickness, percent																					
Under 25.4, excl	± 0.102	± 10																					
25.4 to 38.1, excl	± 0.127	± 10																					
38.1 to 50.8, excl	± 0.152	± 10																					
50.8 to 63.5, excl	± 0.178	± 10																					
63.5 to 88.9, excl	± 0.254	± 10																					
		Note: Tolerances on outside diameter apply only to tubes as finished at the mill before subsequent swaging, expanding, bending, polishing or other fabricating operations. When minimum wall tubes are ordered, tolerances are all plus and shall be double the values shown.																					
Ref. Doc.	Revisions: Refer to record of revisions.	Prepared: Sudhakar	Approved: Subrata Ray	Date of 1 st Issue: 09.12.2016																			



PRODUCT STANDARD
HYDERABAD

COPYRIGHT AND CONFIDENTIAL
 The information on this document is the property of BHARAT HEAVY ELECTRICALS LIMITED. It must not be used directly or indirectly in any way detrimental to the interest of the company.

5.2.2 On straightness:

The tubes shall be free of bends or kinks and the maximum bow shall not exceed Values shown below.

Length, Meters		Maximum Curvature
Over	Upto & Incl	Depth of arc, mm
0.91	1.83	3.2
1.83	2.44	4.8
2.44	3.05	6.4
3.45	--	2.1 mm / m

5.2.3 On Specified Lengths of Tubes:

Specified Lengths of Tubes, Metres	Tolerance, + mm
Up to 7.3 inclusive	+ 3.2
Over 7.3	+ Addl. 3.2 mm for each 3.05 m or fraction thereof up to 13 mm (max.)

5.3 Squareness of Cut:

The angle of cut of the end of any tube may depart from square by not more than 0.016 inch / inch of diameter



PRODUCT STANDARD
HYDERABAD

COPYRIGHT AND CONFIDENTIAL
 The information on this document is the property of BHARAT HEAVY ELECTRICALS LIMITED. It must not be used directly or indirectly in any way detrimental to the interest of the company.

6.0 MANUFACTURE:

Seamless tubes shall be made from hollow billet by any cold reducing or cold drawing process that will yield a product meeting the requirements of this specification. Seamless tube is produced with a continuous periphery in all stages of manufacturing operations.

7.0 FINISH OR FREEDOM FROM DEFECTS:

The finished tube shall be clean and free of foreign material, shall have smooth ends free of burrs and shall be free of injurious external and internal imperfections. Minor defects may be removed, provided the dimensional tolerances of Clause no. 5.2 are not exceeded.

8.0 SURFACE ROUGHNESS:

For the inner surface, the roughness in longitudinal direction shall be allowable within Ra=2 microns or Rz=10 microns.

9.0 CHEMICAL COMPOSITION:

The analysis of the tube material and the permissible variation in the composition of the finished tube from the limits specified shall be as follows:

Element	(Weight) Percent	Permissible Variation (%) in product analysis
Nitrogen	0.03	+ 0.02
Carbon	0.08	+ 0.02
Hydrogen	0.015	+ 0.002
Iron	0.30	+ 0.15
Oxygen	0.25	+ 0.03
Other elements (Each)	0.1	+ 0.02
Other elements (Total)	0.4	--
Titanium	Remainder	--

Note:

1. Lower hydrogen values may be obtained by negotiation with the manufacturer.
2. Percentage of other elements, each need not be reported unless the concentration level is greater than 0.1% each, or 0.4% total.
3. A residual is an element present in a useful or an alloy in small quantities inherent to the manufacturing process but not added intentionally. Ingot hydrogen need not be reported. Final product hydrogen shall be reported.



PRODUCT STANDARD
HYDERABAD

COPYRIGHT AND CONFIDENTIAL
 The information on this document is the property of BHARAT HEAVY ELECTRICALS LIMITED. It must not be used directly or indirectly in any way detrimental to the interest of the company.

10.0 TEST SAMPLES:

10.1 Heat analysis:

An analysis of each heat shall be made by the tube manufacturer to determine the percentage of the elements.

10.2 Product analysis

10.2.1 An analysis of one length of hollow billet or one tube shall be made of each heat to cross check the analysis of the material.

10.2.2 If the original test for the product analysis fails, retests of two additional lengths of hollow billets or tubes shall be made. Both retests, if for the element in question shall meet the requirements of the specification, otherwise all remaining material in the heat or lot shall be rejected or at the option of the producer, each length of hollow billet or tube may be individually tested for acceptance. Length of hollow billets or tubes which do not meet the requirements of this specification shall be rejected.

10.3 Lot:

Number of tubes in a lot heat treated by continuous process shall be as below:

Size of tube	Size of lot
25.4 mm or less in outside diameter`	not more than 125 tubes
Less than 40 mm but over 25.4 mm	not more than 75 tubes

In outside diameter.

The term lot applied to all tubes prior to cutting of the same nominal diameter and wall thickness which are produced from the same heat. When final heat treatment is in a batch type furnace, a lot shall include only those tubes of the same size and the same heat which are heat treated in the same heat furnace charge. When the final heat treatment is in a continuous furnace, a lot as defined above shall include tubes of the same size and heat, heat treated in the same furnace at the same temperature, time at heat and furnace speed.

One tensile, flattening, flaring test per lot shall be conducted.

11.0 MECHANICAL PROPERTIES:

When tested in accordance with ASTM E8, the test pieces shall show the following properties in the annealed condition.

TD 106-2 Rev No.06	Form No.		<p style="text-align: center;">PRODUCT STANDARD HYDERABAD</p>	Prod. Std. No. HE51544
				REV. NO. 02
				PAGE 5 OF 11
<p style="writing-mode: vertical-rl; transform: rotate(180deg);">COPYRIGHT AND CONFIDENTIAL The information on this document is the property of BHARAT HEAVY ELECTRICALS LIMITED. It must not be used directly or indirectly in any way detrimental to the interest of the company.</p>		<p>11.1 Tensile Strength:</p>		
		<p>Tensile Strength : 345 N/mm² (min.)</p>		
		<p>Yield Strength, 0.2% offset : 275 – 450 N/mm²</p>		
		<p>Elongation in 50 mm gauge length : 20% min.</p>		
		<p>11.2 Flattening Test:</p>		
		<p>The tube shall be capable of withstanding without cracking, flattening under a load applied gradually at room temperature until the distance between the load platens is not more than H mm. H is calculated as follows:</p>		
		<p>H =</p>		
		<p>Where</p>		
		<p>H = the min. Flattened height, mm.</p>		
		<p>t = the nominal wall thickness, mm.</p>		
		<p>D = the nominal tube diameter, mm and</p>		
		<p>e = 0.07 for all diameters</p>		
		<p>11.3 Flaring Test:</p>		
		<p>Tubes upto 88 mm outside diameter and upto 3.4 mm in wall thickness and thinner and section of tube approx. 102 mm shall withstand being flared with a tool having 60° included angle until the inner diameter of the tube at the mouth of the flare has been expanded by 20% min. The flared end shall show no visible cracking or rupture.</p>		
		<p>Flaring tests for larger sizes of tubes shall be as agreed upon between the manufacturer and BHEL.</p>		
		<p>12.0 NON DESTRUCTIVE TESTS:</p>		
		<p>Unless otherwise specified each tube shall be subjected to the following tests by the manufacturer.</p>		

TD 106-2 Rev No.06	Form No.		PRODUCT STANDARD HYDERABAD	Prod. Std. No. HE51544
				REV. NO. 02
				PAGE 6 OF 11
COPYRIGHT AND CONFIDENTIAL The information on this document is the property of BHARAT HEAVY ELECTRICALS LIMITED. It must not be used directly or indirectly in any way detrimental to the interest of the company.		<p>12.1 Eddy Current Testing:</p> <p>Test to be performed in accordance with practice E426. The entire volume of the tube shall be tested.</p> <p>Drilled hole – The calibration tube shall contain three or more holes, equally spaced circumferentially around the tube and longitudinally separated by a sufficient distance to allow distinct identification of the signal from each hole. The holes shall be drilled radially and completely through the tube wall with care being taken to avoid distortion of the tube while drilling. The holes shall not be larger than 0.787 mm in diameter.</p> <p>12.2 Ultrasonic testing:</p> <p>Test to be performed in accordance with practice E213.</p> <p>Longitudinal and transverse notches not more than 0.25mm in width and 10% of the nominal tube wall or 0.102mm, whichever is greater, in depth shall be machined on the inner and outer surfaces of the tube. The length of the notch shall not exceed 3.18mm.</p> <p>Any tube showing an indication in excess of that obtained from the calibration standard shall be set aside and be subjected to rework, retest or rejection. A tube thus set aside may be further examined for confirmation of the presence of a defect and may be resubmitted for inspection if no defect is found. Any tube may also be resubmitted for inspection if reworked so as to remove the defect within the specified diameter and wall thickness tolerance specified in clause 5.2.1. Rework by weld repair is not permitted.</p> <p>12.3 Hydrostatic test:</p> <p>Each tube so tested shall withstand, without showing bulges, leaks, or other defects, an internal hydrostatic pressure that will produce in the tube wall a stress of 50% of the minimum specified yield strength at room temperature. This pressure shall be determined by the following equation.</p> $P = SEt / (Ro-0.4t)$		

TD 106-2 Rev No.06	Form No.		PRODUCT STANDARD HYDERABAD	Prod. Std. No. HE51544
				REV. NO. 02
				PAGE 7 OF 11
<div style="display: flex;"> <div style="writing-mode: vertical-rl; transform: rotate(180deg); font-size: small; padding-right: 10px;"> COPYRIGHT AND CONFIDENTIAL The information on this document is the property of BHARAT HEAVY ELECTRICALS LIMITED. It must not be used directly or indirectly in any way detrimental to the interest of the company. </div> <div style="flex-grow: 1;"> <p>Where</p> <p>P = Minimum hydrostatic test pressure, N/mm²</p> <p>S = Allowable fiber stress of one half the minimum yield strength, N/mm²</p> <p>t = Wall thickness, mm</p> <p>Ro = Outside tube radius, mm</p> <p>E = 1.0 for seamless tube</p> <p>However, actual hydrostatic pressure for which the tube shall be subjected to shall be as per PR (Purchase Requisition).</p> <p>12.3.1 The maximum hydrostatic test pressure shall not exceed 17.2 N/mm² for sizes 76 mm OD and under, or 19.3 N/mm² for sizes over 76 mm OD. Hydrostatic pressure shall be maintained for not less than 10 seconds.</p> <p>13.0 RETEST:</p> <p>If the results of any mechanical tests of any lot do not conform to the requirements specified in the Clause no. 11.0, retests shall be made on additional tubes of double the original number from the same lot, each of which shall conform to the requirements specified.</p> <p>14.0 QUALITY ASSURANCE REQUIREMENT:</p> <p>The manufacturer shall conduct all the tests required to ensure that the tubes offered conform to the requirements of the applicable codes and standards, Manufacturer shall submit a detailed quality plan along with his offer as per the standard format which should include all the tests/checks to be carried out by them at the various stages of manufacturing the item. This quality plan shall be reviewed by BHEL and BHEL reserves the right to ask for any more checks, details if required at the time of Quality Plan finalization. The manufacturer shall manufacture the item as per the quality plan duly approved by BHEL.</p> <p>15.0 CHECK LIST;</p> <p>The supplier shall fill up the enclosed check list as per Annexure-A and submit the same along with the offer.</p> </div> </div>				

TD 106-2 Rev No.06	Form No.		<p align="center">PRODUCT STANDARD HYDERABAD</p>	Prod. Std. No. HE51544	
				REV. NO. 02	
				PAGE 8 OF 11	
<p align="center">COPYRIGHT AND CONFIDENTIAL</p> <p>The information on this document is the property of BHARAT HEAVY ELECTRICALS LIMITED. It must not be used directly or indirectly in any way detrimental to the interest of the company.</p>		<p>16.0 DOCUMENTS TO BE FURNISHED:</p> <p>The following documents shall be furnished along with the offer:</p> <ol style="list-style-type: none"> 1. A process chart clearly indicating the sequence of manufacturing. 2. Purchasing specification of mother hollows 3. Heat treatment details. 4. Packing box drawing 5. Quality plan. <p>17.0 INSPECTION AT SUPPLIERS WORKS:</p> <p>BHEL / its representative shall have free access at all times until work on the contract of BHEL is being performed, to all parts of the manufacture's works. The supplier shall offer BHEL'S representative all reasonable facilities, without charge to satisfy the latter that the material is being furnished in accordance with this specification.</p> <p>18.0 TEST CERTIFICATES:</p> <p>Four copies of test certificates shall be supplied unless otherwise stated in the order. The test certificate shall bear the following information:</p> <p>18.1 BHEL REFERENCES:</p> <p>BHEL Order No.</p> <p>HE 5 1544 (Rev. 02): Seamless Titanium Tubes – Grade 2.</p>			

TD 106-2 Rev No.06	Form No.		PRODUCT STANDARD HYDERABAD	Prod. Std. No. HE51544
				REV. NO. 02
				PAGE 9 OF 11
<div style="display: flex;"> <div style="writing-mode: vertical-rl; transform: rotate(180deg); padding-right: 10px;"> <p style="margin: 0;">COPYRIGHT AND CONFIDENTIAL</p> <p style="margin: 0;">The information on this document is the property of BHARAT HEAVY ELECTRICALS LIMITED. It must not be used directly or indirectly in any way detrimental to the interest of the company.</p> </div> <div style="flex-grow: 1;"> <p>18.2 Supplier's References:</p> <ul style="list-style-type: none"> Supplier's Name Test Certificate No. Size & Quantity Identification Marks Process of Manufacture Heat Treatment and Batch Number <p>18.3 Test Results:</p> <p>Results of chemical test / analysis, mechanical and non-destructive tests as per clauses 11 and 12 shall be provided. If specified in Purchase Order, the test certificate shall be attested by BHEL representative / third inspection agency approved by BHEL.</p> <p>19.0 PACKING AND MARKING</p> <p>Packing shall be as per Standard AA 0490002 PRESERVATION PACKING AND MARKING HEAT EXCHANGER TUBES.</p> <p>20.0 REJECTION AND REPLACEMENT:</p> <p>Material failing to confirm to this specification will be rejected. The supplier shall undertake to replace the rejected material at his own cost.</p> <p>21.0 REFERRED STANDARDS:</p> <p>Standards referred in this specification:</p> <ol style="list-style-type: none"> 1) ASTM E8 2) AA 0490002 3) E 426 4) E213 </div> </div>				

TD 106-2 Rev No.06	Form No.		<p style="text-align: center;">PRODUCT STANDARD HYDERABAD</p>	Prod. Std. No. HE51544
				REV. NO. 02
				PAGE 10 OF 11
<p style="text-align: center;">ANNEXURE - A (Clause 15)</p> <p style="text-align: center;">CHECK LIST FOR HE 51544 (To be filled by supplier)</p> <p>(A) Name of Principal Supplier :</p> <p>(B) Name of Indian Agent :</p> <p>1. Grade of material as per specification : Yes/No</p> <p>2. Mechanical properties as per specification : Yes/No</p> <p>3. Annealing : Yes/No</p> <p>4. NDT Test Offered : Yes/No</p> <p style="padding-left: 20px;">i. Hydrostatic test : Yes/No</p> <p style="padding-left: 20px;">ii. Eddy Current test : Yes/No</p> <p style="padding-left: 20px;">iii. Ultrasonic lest : Yes/No</p> <p>5. Test</p> <p style="padding-left: 20px;">1. Flattening test : Yes/No</p> <p style="padding-left: 20px;">2. Flaring test : Yes/No</p> <p>6. Finish of tubes</p> <p style="padding-left: 20px;">Inside side surface Ra= 2 microns or : Yes/No</p> <p style="padding-left: 40px;">Rz=10 microns</p> <p>7. Brief write up on manufacturing : Yes/No</p> <p style="padding-left: 20px;">Process enclosed.</p> <p>8. Quality plan specified by BHEL complied with : Yes/No</p> <p>9. Details of previous experience enclosed : Yes/No</p> <p style="padding-left: 20px;">(For new supplier's only).</p> <p>10. Lifting beam offered. : Yes/No</p> <p>11. Packing box drawing enclosed. : Yes/No</p> <p>12. End guides included (Both cuds). : Yes/No</p> <p>13. Deviation taken (please clearly specify, if any) : Yes/No</p>				

COPYRIGHT AND CONFIDENTIAL
 The information on this document is the property of BHARAT HEAVY ELECTRICALS LIMITED. It must not be used directly or indirectly in any way detrimental to the interest of the company.



BHARAT HEAVY ELECTRICALS
LIMITED
R.C.PURAM, HYDERABAD

STANDARD QUALITY PLAN FOR VENDOR ITEMS

ITEM: SEAMLESS TITANIUM TUBES - GRADE 2
(UNALLOYED TITANIUM)
BHEL SPEC: HE 51544 Rev. 02

QP. NO: HYQA/VSQP/2017-
18/HE/115/1032006900
REV. NO. : 01
DATE: 03.01.2024

PAGE 1 OF 7

SL NO	COMPONENT & OPERATIONS	CHARACTERISTICS	CLASS	TYPE OF CHECK	QUANTUM OF CHECK	REF DOCUMENT	ACCEPTANCE NORMS	FORMAT OF RECORD	* D	AGENCY			REMARKS
										P	W	V	
1.0	RAW MATERIAL INSPECTION												
1.1	MOTHER TUBES	A) IDENTIFICATION OF MOTHER TUBES MARKINGS W.R.TO TC	MAJOR	VISUAL	100%	TEST CERTIFICATE	BHEL SPECIFICATION	TC & INSPN. RECORD		2			HOLD POINT
		B) VISUAL & DIMN. EXAM	MAJOR	VISUAL & MEASRT	100%	TEST CERTIFICATE	BHEL SPECIFICATION	TC & INSPN. RECORD		2			
1.2	VERIFICATION OF MOTHER TUBES TEST CERTIFICATE	A) CHEMICAL COMP.	MAJOR	CHEM.	100%	TEST CERTIFICATE	BHEL SPECIFICATION	TC & INSPN. RECORD	✓	2		1, 3	
		B) MECH. PROPERTIES	MAJOR	MECH.	100%	TEST CERTIFICATE	BHEL SPECIFICATION	TC & INSPN. RECORD	✓	2		1, 3	
2.0	IN PROCESS INSPECTION												
2.1	PILGERING / INTERMEDIATE DRAWING	COLD PILGERING / COLD DRAWING	MAJOR	OD, THK, SURFACE	100%	MFR STD	BHEL SPECIFICATION	IR/LOG RECORD	✓	2		1, 3	
2.2	TUBE WASHING/ CLEANING	SURFACE CONDITION	MAJOR	VISUAL	100%	MFR STD	BHEL SPECIFICATION	IR/LOG RECORD	✓	2		1, 3	
2.3	FINAL DRAWING & SIZING	COLD DRAWN	MAJOR	OD, WALL THK & SURFACE	100%	MFR STD	BHEL SPECIFICATION	IR/LOG RECORD		2		1, 3	
2.4	HEAT TREATMENT	ANNEALED	MAJOR	HEAT TREATMENT	100%	BHEL SPECIFICATION, ASME SB-338 Gr. 2	BHEL SPECIFICATION, ASME SB-338 Gr. 2	H T CHART	✓	2		1, 3	
2.5	STRAIGHTENING	STRAIGHTNESS	MAJOR	OD, SURFACE	100%	BHEL SPECIFICATION	BHEL SPECIFICATION	INSPN. RECORD		2			
2.6.1	UT	INTERNAL FLAWS	MAJOR	NDE	100%	E213./ASME SB 338 Gr2, BHEL SPECIFICATION & PO		INSPN. RECORD	✓	2	1	3	TPIA WITNESS 10%

LEGEND:
P: - PERFORM, W: - WITNESS, V: - VERIFICATION,
INDICATING 1: - BHEL / BHEL NOMMNATED INSPECTION AGENCY, 2: - VENDOR / SUB VENDOR 3:
CUSTOMER /CUSTOMER TPIA AS APPROPRIATE AGAINST EACH COMPONENT / CHARACTERISTICS UNDER
THE COLUMNS P, W & V.

* D: RECORDS IDENTIFIED WITH TICK (✓) SHALL BE ESSENTIALLY INCLUDED IN QA DOCUMENTATION.

PREPARED BY:

ALOK BEHERA
MGR/ QA

REVIEWED BY:

B. ASHOK KUMAR
AGM/QA

APPROVED BY:

B. ASHOK KUMAR
AGM/QA



BHARAT HEAVY ELECTRICALS
LIMITED
R.C.PURAM, HYDERABAD

STANDARD QUALITY PLAN FOR VENDOR ITEMS
ITEM: SEAMLESS TITANIUM TUBES - GRADE 2
(UNALLOYED TITANIUM)
BHEL SPEC: HE 51544 Rev. 02

QP. NO: HYQA/VSQP/2017-
18/HE/115/1032006900
REV. NO. : 01
DATE: 03.01.2024
PAGE 2 OF 7

SL NO	COMPONENT & OPERATIONS	CHARACTERISTICS	CLASS	TYPE OF CHECK	QUANTUM OF CHECK	REF DOCUMENT	ACCEPTANCE NORMS	FORMAT OF RECORD	* D	AGENCY			REMARKS
										P	W	V	
2.6.2	EDDY CURRENT TESTING	INTERNAL FLAWS	MAJOR	NDE	100%	E426 / ASME SB 338 Gr2, BHEL SPECIFICATION & PO		INSPN. RECORD	✓	2	1	3	
2.7	CUT TO LENGTH WITH ALLOWANCE	LENGTH	MAJOR	MEASRT	100%	BHEL SPECIFICATION & PO	BHEL SPECIFICATION & PO	INSPN. RECORD		2			
2.8	SAMPLING FOR TESTING	SAMPLE SELECTION	MAJOR	MEASRT	AS PER SPEC	BHEL SPECIFICATION & PO	BHEL SPECIFICATION & PO	INSPN. RECORD		2	1	3	
2.9	TEST ON TUBES	a) PRODUCT ANALYSIS	MAJOR	CHEMICAL	AS PER SPEC.	BHEL SPECIFICATION, ASME SB-338 Gr. 2	BHEL SPECIFICATION, ASME SB-338 Gr. 2	SUPPLIERS TC	✓	2	1	3	NOTE-5
		b) TS ,YS % ELONGATION	MAJOR	MECH.		TC & INSPN. RECORD	✓	2	1	3			
		c) HARDNESS TESTING	MAJOR	MECH.		TC & INSPN. RECORD	✓	2	1	3			
		d) FLATTENING TEST	MAJOR	MECH.		TC & INSPN. RECORD	✓	2	1	3			
		e) FLARING	MAJOR	MECH		TC & INSPN. RECORD	✓	2	1	3			
3.0	FINAL INSPECTION												
3.1	HYDROTEST	PRESSURE, TIME, LEAKAGE	CRITICAL	HYDRO	100 %	BHEL SPECIFICATION & PO	BHEL SPECIFICATION & PO	HYDROTEST TEST REPORT	✓	2	1	3	CHP, NOTE 2 NOTE 06
3.2	DIMN. CONFORMITY & VISUAL EXAM. SURFACE ROUGHNESS	OD, THICKNESS, LENGTH, STRAIGHTNESS, EDGE BURRS, SURFACE CONDITION.	MAJOR	MEASRT	100%	DRG. / PO & SPEC	DRG. / PO & SPEC	INSPN. RECORD	✓	2	1*	3	* VERIFY & RANDOM WITNESS (10 %) FOR SURFACE ROUGHNESS – RANDOM SAPMLE/LOT

LEGEND:
P: - PERFORM, W: - WITNESS, V: - VERIFICATION,
INDICATING 1: - BHEL / BHEL NOMMNATED INSPECTION AGENCY, 2: - VENDOR / SUB VENDOR 3:
CUSTOMER /CUSTOMER TPJA AS APPROPRIATE AGAINST EACH COMPONENT / CHARACTERISTICS UNDER
THE COLUMNS P, W & V.

* D: RECORDS IDENTIFIED WITH TICK (✓) SHALL BE ESSENTIALLY INCLUDED IN QA DOCUMENTATION.

PREPARED BY:

Alok Behera

ALOK BEHERA
MGR/ QA

REVIEWED BY:

B. Ashok Kumar

B. ASHOK KUMAR
AGM/QA

APPROVED BY:

B. Ashok Kumar

B. ASHOK KUMAR
AGM/QA



BHARAT HEAVY ELECTRICALS
LIMITED
R.C.PURAM, HYDERABAD

STANDARD QUALITY PLAN FOR VENDOR ITEMS

ITEM: SEAMLESS TITANIUM TUBES - GRADE 2
(UNALLOYED TITANIUM)
BHEL SPEC: HE 51544 Rev. 02

QP. NO: HYQA/VSQP/2017-
18/HE/115/1032006900
REV. NO. : 01
DATE: 03.01.2024

PAGE 3 OF 7

SL NO	COMPONENT & OPERATIONS	CHARACTERISTICS	CLASS	TYPE OF CHECK	QUANTUM OF CHECK	REF DOCUMENT	ACCEPTANCE NORMS	FORMAT OF RECORD	* D	AGENCY			REMARKS
										P	W	V	
3.3	CLEANLINESS OF INSIDE SURFACE OF TUBES/ DRAINING & DRYING	CLEANLINESS	MAJOR	VISUAL	100%	DRG. / PO & SPEC	DRG. / PO & SPEC	INSPN. RECORD	✓	2	1*	3	* VERIFY & RANDOM WITNESS (10 %)
3.4	PMI	COMPOSITION	MAJOR	ELEMENTS %	10 %	BHEL SPECIFICATION, ASME SB-338 Gr. 2	BHEL SPECIFICATION, ASME SB-338 Gr. 2	INSPN. RECORD	✓	2	1	3	
4.0	<i>PRESERVATION AND DESPATCH</i>												
4.1	PACKING & DESPATCH	VERIFICATION OF ALL TCS FOR COMPLETION.	MAJOR	VISUAL	100%	PO, SPEC., DRG. & QP	DRG. / PO & SPEC	INSPN. RECORD	✓	2		1, 3	CHP SEE DESPATCH CLEARANCE RECORD TO BE PROVIDED BELOW)
		REVIEW OF REJECTION REPORT	MAJOR	VISUAL	100 %	PO, SPEC., DRG. & QP	DRG. / PO & SPEC	INSPN. RECORD	✓	2		1, 3	
		PACKING & DISPATCH	MAJOR	VISUAL	100 %	PO, SPEC., DRG. & QP	DRG. / PO & SPEC	INSPN. RECORD	✓	2	1	3	

CONFIDENTIAL

LEGEND:
P: - PERFORM, W: - WITNESS, V: - VERIFICATION,
INDICATING 1: - BHEL / BHEL NOMMNATED INSPECTION AGENCY, 2: - VENDOR / SUB VENDOR 3:
CUSTOMER /CUSTOMER TPJA AS APPROPRIATE AGAINST EACH COMPONENT / CHARACTERISTICS UNDER
THE COLUMNS P, W & V.
* D: RECORDS IDENTIFIED WITH TICK (✓) SHALL BE ESSENTIALLY INCLUDED IN QA DOCUMENTATION.

PREPARED BY:

Alok Behera
ALOK BEHERA
MGR/ QA

REVIEWED BY:

Ashok Kumar
B. ASHOK KUMAR
AGM/QA

APPROVED BY:

Ashok Kumar
B. ASHOK KUMAR
AGM/QA



BHARAT HEAVY ELECTRICALS
LIMITED
R.C.PURAM, HYDERABAD

STANDARD QUALITY PLAN FOR VENDOR ITEMS

ITEM: SEAMLESS TITANIUM TUBES - GRADE 2
(UNALLOYED TITANIUM)
BHEL SPEC: HE 51544 Rev. 02

QP. NO: HYQA/VSQP/2017-
18/HE/115/1032006900
REV. NO. : 01
DATE: 03.01.2024

PAGE 4 OF 7

SL NO	COMPONENT & OPERATIONS	CHARACTERISTICS	CLASS	TYPE OF CHECK	QUANTUM OF CHECK	REF DOCUMENT	ACCEPTANCE NORMS	FORMAT OF RECORD	* D	AGENCY			REMARKS
										P	W	V	

DESPATCH CLERANCE / INFORMATION TO BE PROVIDED PRIOR TO MANUFACTURING

BILL OF LANDING (SHIPPING & AIRWAY BILL) AS PER PO
BILL OF ENTRY TO WARE HOUSE (RECIPT AT BHEL)
COUNTRY OF ORIGIN
OEM's TC / CONFORMANCE
CDI PROTOCOL (SEE BLEOW TABLE)

COMPHREHENSIVE DISPATCH INSPECTION (CDI) PROTOCOL

DATE	
PO NUMBER AND DATE	
PROJECT	
OEM DETAILS (ADDRESS, FAX, PHONE NUMBER OF OEM REP)	
EQUIPMENT DESCRIPTION	
EQUIPMENT MAKE, MODEL NO , SERIAL NO	
YEAR OF MANUFACTURING	
QUANTITY	
BOM ID	

LEGEND:
P: - PERFORM, W: - WITNESS, V: - VERIFICATION,
INDICATING 1: - BHEL / BHEL NOMMNATED INSPECTION AGENCY, 2: - VENDOR / SUB VENDOR 3:
CUSTOMER /CUSTOMER TPIA AS APPROPRIATE AGAINST EACH COMPONENT / CHARACTERISTICS UNDER
THE COLUMNS P, W & V.
* D: RECORDS IDENTIFIED WITH TICK (✓) SHALL BE ESSENTIALLY INCLUDED IN QA DOCUMENTATION.

PREPARED BY:

ALOK BEHERA
MGR/ QA

REVIEWED BY:

B. ASHOK KUMAR
AGM/QA

APPROVED BY:

B. ASHOK KUMAR
AGM/QA



BHARAT HEAVY ELECTRICALS
LIMITED
R.C.PURAM, HYDERABAD

STANDARD QUALITY PLAN FOR VENDOR ITEMS

ITEM: SEAMLESS TITANIUM TUBES - GRADE 2
(UNALLOYED TITANIUM)
BHEL SPEC: HE 51544 Rev. 02

QP. NO: HYQA/VSQP/2017-
18/HE/115/1032006900
REV. NO. : 01
DATE: 03.01.2024

PAGE 5 OF 7

SL NO	COMPONENT & OPERATIONS	CHARACTERISTICS	CLASS	TYPE OF CHECK	QUANTUM OF CHECK	REF DOCUMENT	ACCEPTANCE NORMS	FORMAT OF RECORD	* D	AGENCY			REMARKS
										P	W	V	

CHECK LIST FOR DESPATCH

SL	DOCUMENTS	AVAILABILITY: YES/NO	REMARKS
1	PACKING LIST		TO BE ATTACHED WITH PACKING
2	TECHNICAL / INSTALLATION/ MAINTENANCE MANUAL		
3	PRESERVATION PROCEDURE		TO BE ATTACHED WITH I NOTE
4	I-NOTE / DESPATCH CLEARANCE		
5	MARKING OF BOM ID ON EQUIPMENT		BOM ID AND SERIAL NO OF EQUIPMENT TO BE MARKED
6	LIST OF SPARES IF ANY / OOSE ITEMS(FASTNERS, PRESSURE GAUGES, VALVES, COUNTER FLANGE) IF ANY		TO BE ATTACHED WITH PACKING LIST
7	WEIGHT CHECK AS PER PO/ LATEST APPROVED DRAWINGS		CERTIFICATION TO BE ATTACHED WITH I NOTE (SPECIFIC MENTION TO BE MADE REGARDING WEIGHING HAS BEEN DONE WITH MOUNTS /BASE FRAME/ COMPLETE INTEGRAL UNIT WITH MOTOR ETC.)
8	LIST OF ITEMS BEING SUPPLIED BUT NOT IN PO		TO BE ATTACHED WITH PACKING LIST / I NOTE
9	OVER ALL DIMENSIONAL CHECK AS PER LATEST APPROVED DRAWINGS		TO BE ATTACHED WITH I NOTE

CONFIDENTIAL

LEGEND:
P: - PERFORM, W: - WITNESS, V: - VERIFICATION,
INDICATING 1: - BHEL / BHEL NOMMNATED INSPECTION AGENCY, 2: - VENDOR / SUB VENDOR 3:
CUSTOMER /CUSTOMER TPJA AS APPROPRIATE AGAINST EACH COMPONENT / CHARACTERISTICS UNDER
THE COLUMNS P, W & V.

* D: RECORDS IDENTIFIED WITH TICK (✓) SHALL BE ESSENTIALLY INCLUDED IN QA DOCUMENTATION.

PREPARED BY:

Alok Behera

ALOK BEHERA
MGR/ QA

REVIEWED BY:

B. Ashok Kumar

B. ASHOK KUMAR
AGM/QA

APPROVED BY:

B. Ashok Kumar

B. ASHOK KUMAR
AGM/QA



		BHARAT HEAVY ELECTRICALS LIMITED R.C.PURAM, HYDERABAD		STANDARD QUALITY PLAN FOR VENDOR ITEMS				QP. NO: HYQA/VSQP/2017-18/HE/115/1032006900 REV. NO. : 01 DATE: 03.01.2024 PAGE 6 OF 7					
				ITEM: SEAMLESS TITANIUM TUBES - GRADE 2 (UNALLOYED TITANIUM) BHEL SPEC: HE 51544 Rev. 02									
SL NO	COMPONENT & OPERATIONS	CHARACTERISTICS	CLASS	TYPE OF CHECK	QUANTUM OF CHECK	REF DOCUMENT	ACCEPTANCE NORMS	FORMAT OF RECORD	* D	AGENCY			REMARKS
										P	W	V	

NOTES:

- 1) LUBRICANTS USED IN TUBE DRAWING OPERATION SHALL BE NON-CHLORINATED (50 PPM CHLORIDES OR LESS). ALL CLEANING COMPOUNDS SHALL BE CHLORIDE AND CAUSTIC FREE. EACH CLEANING OPERATION SHALL BE FOLLOWED BY A RINSE OR RINSES WITH WATER, THE FINAL RINSE SHALL BE WITH DEMINERALISED WATER CONTAINING NOT MORE THAN 10 PPM CHLORIDES.
- 2) HYDROSTATIC TESTING OF TUBES SHALL BE CARRIED OUT WITH DEMINERALISED WATER.
- 3) TUBES SHALL BE PACKED IN SEA WORTHY PACKING & SHALL BE CAPABLE OF WITHSTANDING MECHANICAL DAMAGES DURING TRANSIT.
- 4) PROJECT SPECIFIC REQUIREMENTS, IF ANY, AS PER PO SHALL ALSO BE COMPLIED WITH. VENDOR HOLDS THE RESPONSIBILITY OF SUPPLYING TUBES TO THE SPECIFICATION AND RELEVANT STANDARDS.
- 5) RESIDUAL ELEMENTS AS PER BHEL SPEC SHALL BE REPORTED IN TC.
- 6) VENDOR TO PERFORM ROOT CAUSE ANALYSIS AND SUBMIT REPORT TO BHEL, IN CASE OF ANY REJECTION OF TUBES DURING HYDROTEST / PNEUMATIC TEST FAILURE.
- 7) IN CASE OF NEW VENDOR (EXECUTING BHEL ORDER FOR FIRST TIME), IN ADDITION TO BHEL TPIA, BHEL QC SHALL ALSO INSPECT/WITNESS STAGE/FINAL INSPECTION AT RANDOM AS A SURVEILLANCE CHECK.
- 8) BHEL TPIA INSPECTION STAGES PHOTOGRAPHS SHALL BE INCLUDED IN QC DOCUMENTATION PACKAGE.

NOTES FOR INSPECTOR - TPIA

1. TPIA TO CHECK THE LATEST VERSION OF STANDARDS/DRAWINGS /TOLERANCES ETC TO BE MENTIONED IN QUALITY PLAN/DRAWING. THIS QP SHOULD BE READ ALONG WITH BHEL SPEC, BHEL DRAWINGS / APPROVED DRAWINGS, DATA SHEET, BOM AND PO.
2. ONLY LEVEL II & ABOVE QUALIFIED PERSON IN RESPECTIVE NDE TO VERIFY OR WITNESS THE NDT TEST REPORT/RESULTS
3. INSPECTOR TO ENSURE THAT DOCUMENTS (QUALITY PLAN, DRAWINGS, DATA SHEET, PURCHASE SPECIFICATIONS, ETC) ARE AVAILABLE AS PER PURCHASE ORDER BEFORE STARTING THE INSPECTION.
4. TPIA TO REVIEW ONLY THE ORIGINAL TEST CERTIFICATES ISSUED BY THIRD PARTY LABORATORIES OR SUPPLIERS.
5. INSPECTION REPORTS SHALL BE SUBMITTED WITH A REMARK THAT ' COMPARED WITH ORIGINAL TEST CERTIFICATE. REVIEWED, VERIFIED AND FOUND IN ORDER '. TPIA TO ENSURE THE SAME.
6. INSPECTOR TO ENSURE USE OF VALID AND CALIBRATED MEASURING INSTRUMENTS AND EQUIPMENT.
7. TPIA SHALL ENSURE THAT MATERIAL TEST CERTIFICATES & TRACEABILITY RECORDS ARE AVAILABLE FOR USE OF CORRECT MATERIAL
8. QUALIFICATION OF EQUIPMENT, PROCESS & PERSONNEL FOR SPECIAL PROCESSES LIKE WELDING, BRAZING, PAINTING & METAL COATING ETC.
9. TPIA TO ENDORSE ON ALL CERTIFICATES WITH COMMENTS (WITNESSED OR VERIFIED) AS PER QUALITY PLAN
10. TPIA SHALL ENSURE THAT LOG SHEETS CONTAIN ACTUAL MEASURED VALUES INSTEAD OF SAYING OK/NOT OK.

LEGEND: P: - PERFORM, W: - WITNESS, V: - VERIFICATION, INDICATING 1: - BHEL / BHEL NOMMNATED INSPECTION AGENCY, 2: - VENDOR / SUB VENDOR 3: CUSTOMER /CUSTOMER TPIA AS APPROPRIATE AGAINST EACH COMPONENT / CHARACTERISTICS UNDER THE COLUMNS P, W & V. * D: RECORDS IDENTIFIED WITH TICK (✓) SHALL BE ESSENTIALLY INCLUDED IN QA DOCUMENTATION.	PREPARED BY:  ALOK BEHERA MGR/ QA	REVIEWED BY:  B. ASHOK KUMAR AGM/QA	APPROVED BY:  B. ASHOK KUMAR AGM/QA
	Format no. : HYQA/QP/VSQP Rev.02		



BHARAT HEAVY ELECTRICALS
LIMITED
R.C.PURAM, HYDERABAD

STANDARD QUALITY PLAN FOR VENDOR ITEMS

ITEM: SEAMLESS TITANIUM TUBES - GRADE 2
(UNALLOYED TITANIUM)
BHEL SPEC: HE 51544 Rev. 02

QP. NO: HYQA/VSQP/2017-
18/HE/115/1032006900
REV. NO. : 01
DATE: 03.01.2024

PAGE 7 OF 7

SL NO	COMPONENT & OPERATIONS	CHARACTERISTICS	CLASS	TYPE OF CHECK	QUANTUM OF CHECK	REF DOCUMENT	ACCEPTANCE NORMS	FORMAT OF RECORD	*	AGENCY			REMARKS
										D	P	W	

11. COMPLETE INSPECTION AND TEST DOCUMENTATION WHICHEVER IS IDENTIFIED WITH (v) UNDER COLUMN D OF APPROVED QULAIITY PLAN SHALL BE ENCLOSED WITH THE INSPECTION REPORT. ALL TEST CERTIFICATES/ REPORTS REVIEWED AND CERTIFIED BY BHEL/TPI SHALL BE SUBMITTED TO BHEL AS DOCUMENTATION PACKAGE

12. ORIGINAL COPIES OF ALL INSPECTION AND TEST DOCUMENTS AUTHENTICATED BY TPIA SHALL BE SUBMITTED.

GENERAL NOTES

- BHEL RESERVES THE RIGHT FOR CONDUCTING REPEAT TEST, IF REQUIRED.
- BHEL APPROVED INSPECTION ENGINEERS TO BE DEPLOYED FOR INSPECTION.
- DRAWING / DATA SHEET SHALL PREVAIL OVER QUALITY PLAN IN CASE OF ANY CONTRADICTION BETWEEN QUALITY PLAN AND DRAWING / DATA SHEET.
- ALL TEST REPORTS SHALL BE PROVIDED AS PER PRESCRIBED FORMATS IN BHEL SPEC.
- ANY OTHER TESTS/ CHECKS INDICATED IN SPECIFICATION, P.O., OR DRAWING & ANY ADDITIONAL CHECKS ENVISAGED BY BHEL/TPI TO ENSURE WORKMANSHIP, FINISH, AESTHETICS, ETC. SHALL ALSO BE CONDUCTED AND WITNESSED/VERIFIED BY BHEL /TPI / CUSTOMER AS REQUIRED

CONFIDENTIAL

LEGEND:
P: - PERFORM, W: - WITNESS, V: - VERIFICATION,
INDICATING 1: - BHEL / BHEL NOMMNATED INSPECTION AGENCY, 2: - VENDOR / SUB VENDOR 3:
CUSTOMER /CUSTOMER TPIA AS APPROPRIATE AGAINST EACH COMPONENT / CHARACTERISTICS UNDER
THE COLUMNS P, W & V.

* D: RECORDS IDENTIFIED WITH TICK (✓) SHALL BE ESSENTIALLY INCLUDED IN QA DOCUMENTATION.

PREPARED BY:

ALOK BEHERA
MGR/ QA

REVIEWED BY:

B. ASHOK KUMAR
AGM/QA

APPROVED BY:

B. ASHOK KUMAR
AGM/QA



CORPORATE STANDARD

AA 049 00 02

Rev. No. 02

PAGE 1 OF 4

PRESERVATION, PACKING AND MARKING OF HEAT EXCHANGER TUBES

1.0 SCOPE:

This standard stipulates the requirements of preservation, packing and marking of ferrous and non ferrous heat exchanger tubes.

2.0 PRESERVATION:

2.1 End Caps/Guides:

All the tubes shall be provided with plastic end caps of conical shape on both sides, in order to avoid ingress of water and other foreign matter and to serve as a guide for tube insertion through the support plates during assembly of the Heat exchangers.

A typical figure of the plastic guide is shown in the fig 2 for guidance.

2.2 Rust prevention:

All carbon steel tubes shall be applied with suitable temporary rust preventive on the outer surface of the tubes and required quantity of rust inhibitive powder shall be inserted inside the tubes before end capping.

3.0 PACKING:

3.1 The tubes shall be wrapped with polythene sheet in order to avoid movements and rubbing and packed in wooden cases (as an alternate bubble sheet and thermocol also acceptable) with suitable cushioning materials. The bottom of the case shall be rigid to enable the tubes to maintain straightness. Special lifting tackles, including beams, wherever necessary shall be provided with each case to avoid damage during transit. The case shall be fastened with corner metal plates and nailed at all cleats. The reinforcing bolts shall be bound with band steel.

A suitable amount of desiccant such as silica gel shall be placed in each packing box.

3.2 Each package shall be of convenient weight for ease in handling. The weights shall not exceed 2000 kg (Gross) when tubes longer than 7000 mm are ordered.

3.3 The recommended packing case design and the method of packing is illustrated in Fig. No.1 Any alternate method of packing shall be submitted to BHEL for approval.

Revisions :

Cl. 18.11.01 of MRC – NFCW+HE

APPROVED :

INTERPLANT MATERIAL RATIONALIZATION
COMMITTEE-MRC (NFCW+HE)

Rev. No. 02

Amd.No.

Reaffirmed

Prepared

Issued

Dt. of 1st Issue

Dt: 15.02.2004

Dt :

Year :

HARDWAR

Corp. R&D

APRIL, 1985

**4.0 MARKING:**

4.1 Each tube shall be stenciled with the following information:

- a) BHEL order number:
- b) BHEL Specification No.
- c) Melt/Heat No:
- d) Size of tube:
- e) Supplier 's mark

4.2 A metal label shall be securely attached to each packing case, punched with the following details :

- a) BHEL order number:
- b) BHEL Specification No.
- c) Consignment or Identification No.
- d) Size of the tubes and Total weight
- e) Supplier's Name

4.3 The packing case shall be marked with the following symbols in order to avoid damage during transit:

- a) A mark indicating UP-DOWN position of the case.
- b) A mark indicating that the case shall not be given any impact.
- c) A mark indicating that the case shall be kept free from contact with moisture.
- d) A mark showing the slinging position.

5.0 HANDLING AT PORT, SITE, SHOP, ETC., 9INCLUDING TRANSPORTATION):**5.1 Procedure:**

If the tube length is more than 7000 mm invariably beams are ordered by BHEL, two in numbers which are supplied with first consignment by the vendor.

On receipt of consignment at port, boxes and lifting beams shall be inspected. If boxes are found broken, inspection of tubes shall be carried out. Broken box shall be suitably repaired before sending to site. Boxes shall be inspected before loading on the truck/trailer at supplier's works. Repair shall be carried out if required.

Invariably lifting beam shall be used for handling of boxes.

Boxes shall be placed on the floor on supports (at least 300 mm above the floor). Distance between supports shall not be more than 500 mm. While handling /stacking, vertical direction as marked on the box shall be followed.

Boxes shall be stacked on each other in such a way that are upright, straight and not projecting outside the lower box. Normally not more than 3 boxes shall be kept on each other.



CORPORATE STANDARD

AA 049 00 02

Rev. No. 02

PAGE 3 OF 4

5.2 Loading of boxes on trailers/trucks:

Preferably trailer shall be of flat floor and its length shall not less than the box. However, in case it is not feasible, following is recommended:

<u>Box length max. in metres</u>	<u>Floor length not less than in metres</u>
20	18.5
15	14
10	9.5
8	7.6

In case, the floor of trailer/truck is not flat, following procedure shall be adopted:

- Packers of suitable strength shall be placed on the floor such that when boxes are placed, the packer's bottom of the boxes is horizontal.
- Packers shall be placed such that at the driver end, the box projects maximum 300 mm from the support and on the opposite end, it is 300 mm less than end of the floor such that total projection from last support shall not be more than as specified above.
- Boxes shall be placed on each other as specified in clause 5.1. The each vertical row shall be secured tight using ropes /wires and tightened with each other and secured with the trailer floor suitably. The gap between the tightening rope/wire shall not be more than 2 metres.
- Out of two lifting beams, one number shall be sent with first consignment and the second lifting beam with the last consignment.
- Boxes shall be covered with tarpaulin and tightened suitably so as to prevent seepage of water.

5.3 Receipt at site:

The boxes shall be again inspected at the site for any breakage, if found shall be reported back to concerned unit.

The boxes from trailer/truck shall be lifted using lifting beam only supplied with the first and last consignment and stacked in the store in line with clause 5.1.

The boxes shall be covered with tarpaulin to prevent water seeping in the boxes.

6.0 REFERRED STANDARDS (LATEST PUBLICATIONS INCLUDING AMENDMENTS):

NIL

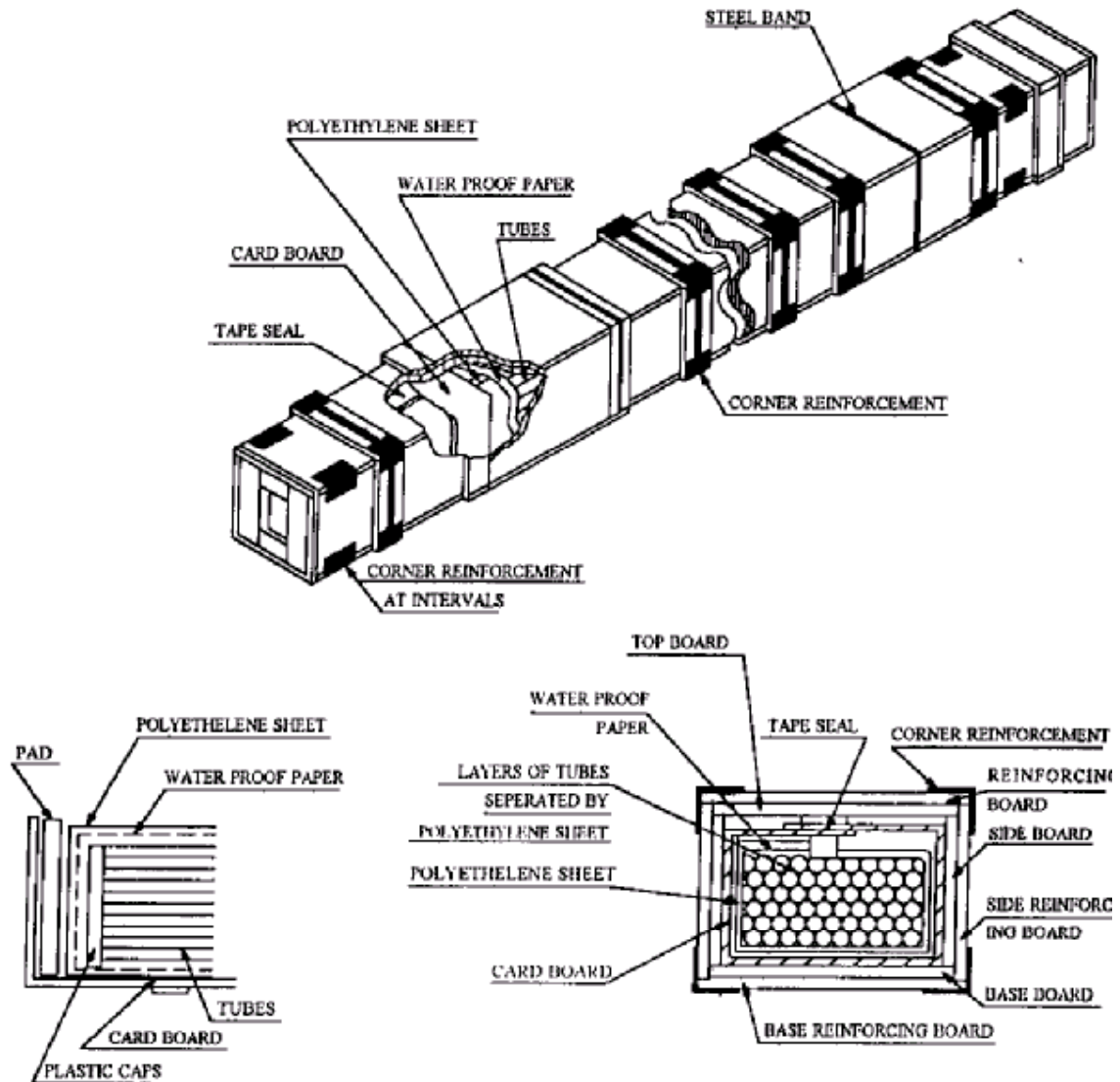

FIG. 1 TYPICAL PACKING OF HEAT EXCHANGER TUBES

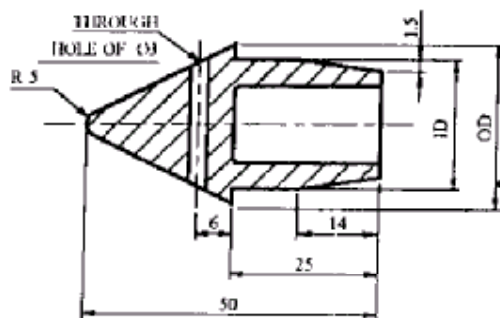

FIG. 2 TYPICAL DRAWING OF CAP FOR TUBE END

(All dimensions are in mm)



(Attachment to Enquiry No. D3A1X20421 Due on Date 17.02.2024 for submission by 11.00 hrs to open from 14.00 hrs.)		
INSTRUCTIONS TO BIDDER (ITB)		
NOTE: Bidder to confirm in affirmative by typing "YES" or "Applicable Data" in the response column. Deviations, if any shall be recorded in deviations/comments column (Separate sheet can be attached if needed). Non deviatable clauses are indicated as "NON DEVIATABLE".		
Sl. No.	DETAILED TERMS & CONDITIONS	BIDDER RESPONSE (YES/NO) / DEVIATIONS / COMMENT
1	SCOPE OF SUPPLY:	
	Signed & Sealed offers are invited for the Scope of Supply of goods or services or both as detailed in the enquiry. Relevant enclosures/supporting documents / catalogue, if any shall be enclosed to the technical offer.	
2	DEFINITIONS	
A	'The Buyer' means BHEL-HPEP, Ramachandrapuram, Hyderabad-502 032 of Bharat Heavy Electricals Limited (A Govt. of India Undertaking) incorporated under the companies Act having its registered office at BHEL House, Siri fort, New Delhi-110049, India and shall be deemed to include its successors and assigns. It may also be referred to as BHEL.	
B	'The Bidder' means the persons, firm, company or organization on whom the Purchase order is placed and shall be deemed to include the bidder's successors, representatives, heirs, executors and administrator as the case may be. It may also be referred to as Contractor, supplier or bidder.	
C	'Contract' shall mean and include the Purchase order incorporating various documents viz., Notice Inviting Tender (NIT), Offer, Letter Of Intent/Acceptance (LOI/LOA), Instruction to Bidders (ITB) and Special Conditions of Contract (SCC), specifications, inspection/quality plan, schedule of prices and quantities, drawings, if any, enclosed by Bidder/ provided by the Buyer or his authorized nominee and the samples or patterns if any to be provided under the provision of the contract. In case of any inconsistency or contradiction between any of the documents, the order of precedence shall be Purchase Order, LOI/LOA followed by Minutes Of Meeting (MOM), NIT, SCC, ITB.	
D	'Parties to the contract' shall mean the bidder and the buyer as named in the main body of the Purchase Order.	
E	'Goods/Material' shall include Works and Services which are incidental or consequential to supply.	
3	GENERAL INSTRUCTIONS:	
A	Mode of submission of offer shall be as indicated in SCC	Non Deviatable
B	The quotation should be neatly typed and free from over writing/ erasures. Any correction or addition must be authenticated. The offer including annexures and brochures should be submitted in English / Hindi. All Pages of Techno Commercial Bids (Main Pages), ITB, SCC should be signed and Stamped. If there is a conflict in case of bilingual submission, the submission in English will be final. Prices shall be quoted both in figures and words. In case of any discrepancy in value, the prices quoted in words shall be considered for evaluation and establishing L1 Status. Any discount / revised offer / bids submitted by a bidder on his own shall be considered, provided it is received on or before the due date and time of offer / bid submission (Part-1). Conditional discounts shall not be considered for evaluation of tenders.	Non Deviatable
C	Incomplete offers are liable for rejection.	Non Deviatable
D	Bidders to please note that the Terms & conditions contained in this document and SCC are to be read fully before submission of quotations.	Non Deviatable
E	Bidders are advised to comply with ITB and SCC, should there be any deviations (where deviations are permitted), it shall be entered in the deviation column. BHEL reserves the right to reject such offers or load the bid suitably for evaluation.	Non Deviatable
F	Offers shall be submitted directly, only by the bidder or by their authorized representative / agent and the offer should be in line with the regulatory guidelines (i.e. A valid Agency agreement between principal bidder and agent / representative shall be attached and the agreement shall cover the scope of services rendered by Agent, Agency Commission and any other information called for as per the regulatory guidelines). OEM / Mill details shall be provided if bidder is not a manufacturer. Bid envelops shall bear the name of Bidder. In case of submission through authorized representative/agent, the name of representative/agent should also be mentioned apart from bidder name.	Non Deviatable
G	Offer received after the specified time and date of submission will be rejected. No further correspondence shall be entertained.	Non Deviatable
H	Unsolicited offers will not be considered.	Non Deviatable
4	OTHER PARTICULARS (Please indicate applicable data)	
A	Name of the Bid currency (freely tradable foreign currency for imports and Indian Rupees for indigenous purchase).	
B	Name of the Port of loading and Port of Discharge (applicable to imports).	



5	BID SUBMISSION PROCEDURE FOR CONVENTIONAL TENDER:	
A	For Single Part Bids:	
	The complete bid shall be submitted in a single sealed cover superscribing the Tender number and due date, addressed to Sr DGM/CMM, Vendor Complex, BHEL, Hyderabad and sent by appropriate mode to above address or dropped in tender box located at vendor complex on or before the specified time and date of submission of offers, preferably in the bidder's envelope. E- mail bids shall be sent to mail ID pricebid_hyd@bhel.in only as an attachment.	Non Deviatable
B.	For two-Part Bids:	
i	The offer is to be submitted in two parts viz., Techno-commercial Bid - (Part-I), with all technical specification & scope including bill of material etc., Earnest Money Deposit (EMD)(wherever applicable) and unpriced bid with all applicable Commercial Terms and Conditions, rates of agency commission, duties, taxes and other charges, Signed and Stamped ITB and SCC, <u>except the price</u> , shall be kept in a separate sealed cover, superscribing enquiry No. (Techno-Commercial Bid) and due date AND Price Bid (Part-II), containing ONLY the price (including agency commission, if any) and the applicable duties/taxes/other charges shall be kept in a separate sealed cover superscribing Enquiry no. (Price bid) & due date. Both the above covers (Part –I & II) shall be kept in a Third cover superscribing Enquiry no. & due date. Bidder can also submit offer through email. Technical offer to be submitted to mail ID technicalbid_hyd@bhel.in, and price bid to be submitted to mail ID pricebid_hyd@bhel.in only as an attachment. Interchanging the information in the mails may lead to rejection of the offer. Bidder shall have no claim on e-mail offers sent to any other e-mail ID. In case of e-mail offers, the mail subject should contain Enquiry Number, Due date and Bidder name. Bidder address including contact details shall be mentioned in the content of the mail. Without these details, the offer is liable for rejection. All techno commercial terms & conditions mutually agreed prior to price bid opening shall prevail and supersede any terms and conditions specified otherwise in price bid.	Non Deviatable
ii	The bidders whose bids are techno commercially not accepted will be informed and EMD shall be returned wherever submitted.	
iii	Bidders will be allowed to submit the impact on their quoted prices due to changes in technical scope, specifications, and commercial terms/conditions as specified in NIT which in the opinion of BHEL , warrant changes in prices.	Non Deviatable
C	Bids shall be opened on due time and date in the presence of bidders who may like to be present. Only one representative of each bidder shall be permitted to attend the bid opening. Only the price bids of bidder (in case of two part bid) whose techno commercial bids are accepted will be opened later on a specified date.	Non Deviatable
6	DELIVERY TERMS	
A	Indigenous Purchase	
	a. Terms of Delivery for dispatches to BHEL Hyderabad (HPEP) shall be FOR Destination. b. Terms of Delivery for Direct Dispatch (DD) items shall be Ex Works. i. In case specified in SCC that insurance is in customer/BHEL scope, price quoted shall include Freight charges up to Destination. ii. Otherwise, price quoted shall include Freight and Insurance upto Destination. However, beneficiary for insurance shall be BHEL.	
B.	Imports	
	The goods shall be delivered on FCA capital airport basis in case of freight by Air and CIP basis in case of freight by Sea.	
7	Documentation for Payment	
A	Indigenous Purchase	
	Following documents shall be submitted immediately on dispatch of material to BHEL HPEP / Site a. Original Tax Invoice (Refer ITB clause no 11 for Tax Compliance) b. Packing List - clearly showing number of packages, gross weight and net weight. c. Test/Warranty/Guarantee certificates, O&M Manual (If specified in SCC) d. Insurance intimation/declaration certificate e. Pre-dispatch Inspection report /Third Party Inspection Certificates. f. Consignee copy of LR signed & stamped by Customer/Site representative for DD Items g. e-waybill h. Any other documents as specified in SCC. Softcopies of the above documents shall be uploaded in Pradan portal https://hpep.bhel.com/mm immediately after dispatch of the material.	Non Deviatable



B	<p>Imports</p> <p>i) Bidder shall inform BHEL the readiness of material along with packing details 30 days in advance from the date of delivery. For Hazardous cargo/DG cargo, supplier must provide the following documents prior to handing over shipment to freight forwarder, wherever freight is in BHEL scope:</p> <ol style="list-style-type: none"> 1. Valid MSDS 2. DGD certificate with appropriate UN numbers. 3. Labelling and marking on DG cargo along with photo of packaging. 4. Self-declaration for consignment 5. Packaging Certificate as per DG Standards 6. TSA Approved Truckers details to be provided to forwarder at the time of shipment <p>In addition to the above, supplier should ensure to comply all IATA DG regulations, if any new requirement is added in future.</p> <p>ii). Bidder shall also upload the soft copy of the dispatch documents consisting of BL / AWB, Invoice, delivery note, packing list, country of origin & Test certificates and other documents as specifically indicated in the SCC in PRADAN Portal (https://hpep.bhel.com/mm) within Five days from the B/L date for sea shipment and One day from AWB date for Air shipment and sent to email ids: mssea@bhel.in, msair@bhel.in, cmmfe@bhel.in.</p> <p>iii) AWB/BL must contain the information of BHEL GST no., and PAN no.</p> <p>iv) Air Shipments: Bidder shall ensure the following</p> <ol style="list-style-type: none"> a) Port of discharge -- Mumbai/Chennai/Hyderabad (as indicated in SCC). b) Consignee shall be BHEL, Hyderabad. Material shall be air freighted through cargo mode only and not through Courier. c) Upon handing over the cargo to the forwarder, bidder shall ensure the acknowledgement receipt with wordings "Cargo handed over in sound condition for Air freighting". Note: Warehouse receipt will not be considered for penalty calculations. d) In case of CIF/ shipments, bidder shall also inform BHEL the information about discharge port agent details and cargo arrival information within one day from the date of Shipment. e) Following dimensions of single package may be noted. <ol style="list-style-type: none"> i). Maximum dimension of the cargo(ODC) -- 125" x 88" x 63" ii). Maximum weight of the cargo -- 3.5 MT. <p>If any package dimension or weight exceeds the above set limits, it will be treated as Over Dimension Cargo (ODC) or Over Weight Cargo and bidder shall inform BHEL 30 days in advance to the delivery date to enable BHEL to finalize the freight forwarder.</p> f). If package falls under Hazardous category, bidder shall communicate BHEL 30 days in advance period with document support. <p>v) Sea Shipments:- bidder shall ensure the following</p> <ol style="list-style-type: none"> a). Port of discharge -- Nhavaseva/Mumbai/Chennai. b). Place of Delivery / Final Destination for CIP shipments - Nhavaseva CFS / Chennai CFS. c). In case of FOB shipments, bidder shall handover the material to BHEL nominated forwarder and obtain the cargo receipt. d). If the material cannot be containerized in 20 or 40 GP containers, an advance information of 30 days prior to the delivery date shall be communicated to BHEL for necessary arrangements and finalisation of freight forwarder. e). For CIP shipments <ol style="list-style-type: none"> 1. In case of FCL shipments, Detention free period must be 14 days. 2. Bidder shall also inform BHEL the information about discharge port agent details and cargo arrival information within 5 days from the date of Shipment. 3. No charges for the services rendered till place of destination will be payable by BHEL. In case liner / forwarder insist for charges, not in the scope of BHEL, the same will be adjusted from bidder account. 4. In case of CIF shipments -- Bidder must select a forwarder/liner whose discharge port published tariff for THC and other services is available. Any charges over and above the published tariff will not be borne by BHEL or will be adjusted from the bidder's bill. 5. bidder must insure the cargo for 110% of material value including the freight amount. (vi). Recovery charges for non-submission of documents: - Bidder shall submit all the required documents to BHEL as prescribed in the Purchase order and NIT. <p>If BHEL incurs any charges such as Penalty, demurrage, container detention, wharfage, storage, Ground rent etc., due to non - compliance / non - submission of documents prescribed in Purchase Order/ NIT/Letter of credit, the same shall be recovered from the bidder as under:</p> <ol style="list-style-type: none"> 1. EUROPE/USA/Black Sea/ Far East/Middle East/South East sector <p>A. For FOB Sea Consignments:-</p> <p>Penalty for late submission / negotiation of documents beyond 14 days shall be as under:</p>	
----------	--	--



Sl. no	Period (From Date of Bill of Lading)	Recoverable Charges	Recoverable Charges per day per container	
		LCL per week/ Break bulk cargo per day	20FT Container	40FT Container
i	Upto 14th day	Nil	Nil	Nil
ii	15th day onward	USD 10	USD 110	USD 200

B. For CIP Sea Shipments: -
Bidder shall provide rates for detention charges after free period at the time of offer itself in case of engagement of 20FT Container and 40FT category. In case of late presentation of documents to the bank recovery will be effected from the Bidder as per the rates quoted by the Bidder at the time of offer in this regard.
In case of Break bulk cargo and LCL, Demurrage charges shall be recovered at the rate of USD 1 per Ton per day and storage charges at the rate of USD 10 per week respectively shall be charged as late presentation charges.

(vii) Description of items in invoice, packing list, BL / AWB or LR shall be same as PO item description. Bidders shall ensure that invoice shall contain PAN nos. of both bidder and BHEL along with other tax related numbers. BHEL PAN AAACB4146P and BHEL TAN HYDB00086C Any other additional documents sought by the statutory authorities, the same shall be produced by the bidder on priority basis.

(viii) Bidder shall provide package details including number of packages, gross weight, net weight etc.

(ix) The bidder shall provide the following documents at the time of submission of offer:
a) No Business Connection in India declaration issued by the bidder as per the format specified. (or)
b) (i) No Permanent Establishment in India declaration issued by the bidder as per the format specified.
(ii) Tax Residence Certificate issued by the bidder's tax authorities.
(iii) Form 10F, as attached in Annexure V, to be issued by the bidder.
c) In case the bidder has a Business Connection in India as per Section 9 of Income Tax Act or significant economic presence in India as per rule 11 UD of IT Act or Permanent Establishment in India as per Article 5 of Double Taxation Avoidance Agreement between India and the bidder's country, the bidder shall provide a withholding tax order issued by the Indian Income Tax authority for recovery of applicable tax.

8	Delivery Schedule		
	The tendered goods shall be delivered within the period stipulated in NIT/ SCC as accepted. Inordinate delay/early supply are liable for rejection/Hold on payment.		Non Deviatable
9	Pricing Terms		
	Quoted price shall be inclusive of Packing & Forwarding and shall remain firm and valid during the execution of PO. Offers with PVC will be rejected outright except in cases where specifically called for in the SCC.		Non Deviatable
10	PRICE VALIDITY :		
	Unless otherwise specified, offer shall be valid for a period of 90 days from the date of bid opening (Technical bid /part-I in case of two part bid). However the prices quoted for spare parts of the Main equipment shall be kept valid for a period as specified in SCC.		Non Deviatable
11	Taxes & Duties (RATE TO BE INDICATED by the bidder against the space provided)		



A	<p>Indigenous Purchase</p> <p>i) Only valid GST registered bidders will be considered for the tender. The GSTIN of the bidder should be clearly mentioned in the offer.</p> <p>ii) If bidder is exempted from GST registration under any provision of the GST Law, a declaration with due supporting documents should be furnished for considering the offer.</p> <p>iii) Bidder to quote the applicable taxes in the following manner: - Harmonized System of Nomenclature (HSN) of Goods - Services Accounting Code(SAC) of Services. - IGST/CGST/SGST/UTGST: Rate of Tax to be quoted as extra in % against the space provided</p> <p>iv) Bidders to ensure correct applicability of IGST/CGST/SGST/UTGST based on the Inter / Intra state movement of goods/services.</p> <p>v) In case Bidder has opted for GST Composition Scheme, the same may be stated explicitly both in their technical and price bids. An undertaking to the effect that any change in the status of the bidder will be intimated.</p> <p>vi) Any other taxes & duties not covered anywhere above may be indicated separately.</p> <p>Taxes deducted at source: - TDS as per the extant statutes shall be deducted. - In case bidder does not provide PAN details, higher rate of tax shall be deducted as per the Act. - Concessional certificates, if any, should be provided well in time for lower deduction of tax.</p>		Non Deviatable
B.	<p>Terms & Conditions to be complied</p> <p>1. All invoices (incl. Credit Notes, Debit Notes) to contain BHEL HPEP GSTIN ie 36AAACB4146P1ZG. Invoices submitted should be in the format as specified under GST Law. All details as mentioned in Invoice Rules including Dealer GST registration number (GSTIN), invoice number with date of issue, quantity, rate, value, taxes with nomenclature – CGST, SGST, UGST, IGST mentioned separately, HSN Code / SAC Code etc.</p> <p>2. Reimbursement of GST amount will be made only upon completion of the following: i. Bidder declaring such invoice in their GSTR-1 Return/ IFF ii. Receipt of Goods or Services and Submission of Tax invoice by BHEL iii. The tax invoice is reflected in the GSTR2B of BHEL, HPEP (buyer). Payment of GST will be made only if it is matching with data uploaded by the Bidder in GST portal.</p> <p>3. In case of discrepancy in the data uploaded by the bidder in the GSTN portal vis-a-vis the tax invoice or in case of any shortages or rejection in the supply, then BHEL will not be able to avail the tax credit. The same would be available in PRADAN Portal for the bidder's information. Bidder has to rectify the data discrepancy in the GSTN portal or issue credit note or debit note (details also to be uploaded in GSTN portal) for the shortages or rejections in the supplies or additional claims for processing of such invoices.</p> <p>4. In cases where invoice details have been uploaded by the bidder but failed to remit the GST amount to GST Department within stipulated time, then GST on the invoices in default will be recovered from the bidder along with the applicable interest.</p> <p>5. In case GST credit is delayed/denied to BHEL due to non/delayed receipt of goods and/or tax invoice or expiry of timeline prescribed in GST law for availing such ITC, or any other reasons not attributable to BHEL, such GST amount will be recoverable from bidder along with interest levied/leviable on BHEL.</p> <p>6. GST TDS deducted as per GST Act, is uploaded in GSTN portal along GSTR7. Bidders can directly download the GST TDS Certificate from the GSTN Portal.</p> <p>7. Bidders to note that Rules & Regulations pertaining to E-way bill system are to be strictly adhered to, as and when notified by Govt. authorities.</p> <p>8. Vendors who fall under the E-Invoice regulations, i.e., having an annual turnover of Rs. 10 crores (Rs 5 crore w.e.f 01.08.2023) in the previous year shall issue e-invoice in line with Rule 48(4) of CGST Rules failing which GST amount will not be reimbursed to the vendor even if the other requirements are fulfilled.</p> <p>9. In case the vendor is exempted by the GST department under the Rule 48(4) of CGST Rules from issuing E-invoice, a declaration as prescribed in the Notification 17/2022 - Central Tax dated 01-08-2022 shall be provided on the invoice.</p> <p>10. Vendors who do not fall under the E-Invoice regulations, i.e., whose annual turnover is less than Rs. 10 crores (Rs 5 crore w.e.f 01.08.2023) in the previous year have to give an undertaking indemnifying BHEL that the vendor is not falling under the E-invoice requirement category and that in case of any breach of this E-invoicing requirement, the vendor indemnifies BHEL of any consequences that may arise due to such a breach.</p> <p>11. No GST shall be levied on liquidated damages / penalty.</p>		
	<p>Foreign Purchase (Imports)</p>		



	<p>The offered price shall be inclusive of all the Taxes and duties as applicable in country of export / country of dispatch for the quoted price.</p> <p>Taxes deducted at source:</p> <p>a. In case of goods or services subject to Income tax in India, such tax as per the extant statute shall be recovered.</p> <p>b. In case bidder does not provide necessary documents for beneficial taxation (Refer clause 7-B-(ix) a-c of ITB), the TDS deduction shall be at the maximum percentage stipulated as per the provisions of Income Tax Act.</p>		Non Deviatable
12	Payment Terms: Unless otherwise specified in SCC, following shall be the terms of Payment.		
A	<p>Indigenous:</p> <p>a. Micro & Small Enterprises (MSEs) - 100% Direct EFT payment within 45 days</p> <p>b. Medium Enterprises - 100% Direct EFT payment within 60 days</p> <p>c. Non MSME Bidders - 100% direct EFT Payment within 90 Days</p> <p>Note</p> <p>A. Above due date is reckoned from the date of Receipt of material or 15 days from the date of submission of complete set of documents as per PO whichever is later. Payment will be made on acceptance of Material.</p> <p>B. MSEs (covered under MSME Act) need to register and renew periodically and update the same with BHEL</p> <p>C. The taxes that are reimbursed are limited to applicable taxes as on the Purchase Order delivery date or the amount actually paid whichever is less.</p> <p>D. Adherence to the above time schedule of payment is contingent upon Bidder complying with GST provisions and availment of Input Tax Credit by BHEL before the date of payment.</p> <p>E. In case of packaged items, 10% of supply value will be retained till completion of total supplies.</p> <p>F. Bidders to comply with clause 11 on GST requirements</p> <p>G. MSE benefits are not applicable to Traders/Wholesalers registered as MSEs</p>		
B	<p>Imports:</p> <p>i) 100% payment (less Indian Agency Commission, if any) shall be through Wire Transfer with a credit period of 60 days - Cash Against Documents (CAD)</p> <p>ii) In case Bidder opts for Letter of Credit payment, the LC Usance period shall be 90 days with respective bank charges to respective accounts and loading of 0.50%</p> <p>iii) Indian Agency commission if payable and so specified in the Purchase order shall be paid in Indian Rupees, considering the SBI TT selling exchange rate, as on the date of payment after successful completion of the contract.</p>		
C	<p>Conditions for LC:</p> <p>a. LC validity period will be 90 days and for any extension, applicable charges will be to bidder's account.</p> <p>b. LC will be opened after successful completion of pre dispatch inspection prior to the scheduled / agreed delivery date. LC will be opened within 15 bank working days from the date of request.</p>		Non Deviatable
D	<p>Conditions for both Indigenous & Foreign Bidders:</p> <p>a. In case Bidders insist for lesser Credit period and BHEL accepts, a loading of 0.60% for every 15 days reduction will be applicable.</p> <p>b. In case PBG as required is not furnished, Payment will be released deducting the BG amount, which will be paid after expiry of warranty period against submission of supplementary claim.</p> <p>c. Payment does not imply in any respect whatsoever a waiver of Buyer's right to performance of the Order. Buyer is entitled to set off claimable debts against claimable liabilities with the bidder by means of a setoff Note.</p>		Non Deviatable
E	<p>Wherever EMD is applicable, the EMD will be paid back to unsuccessful bidders within fifteen days after award of the contract. Successful bidder's EMD will be retained till submission of Performance Bank Guarantee (PBG).</p> <p>Tender Fee wherever applicable is not refundable.</p> <p>No interest shall be payable by BHEL on earnest money or security deposit or any money due to the contractor by BHEL.</p>		Non Deviatable



13	<p>Penalty clause:</p> <p>In the event of delay in supply /part-supply of goods, Penalty as detailed below is leviable</p> <p>a. Penalty of 0.5% per week or part there of shall be levied, limited to a max of 10% (ten percent) of delayed portion value / order value (as specified in SCC).</p> <p>b. Penalty applicable for delay in documentation is as per SCC.</p> <p>c. Date Reckoned for Penalty</p> <ul style="list-style-type: none"> - Indigenous Orders with delivery terms FOR HPEP: C Note date. - Indigenous Orders (Others): Date of e-waybill. - Imports: For CIP/CIF Orders: IGM date - Imports: For FOB Orders: AWB / BL date - Imports: For FCA/Ex Work Orders: Date of acknowledgement from Freight Forwarder. <p>d. In case of Deviation to above Penalty clause, loading applicable to the extent to which not agreed by Bidder.</p> <p>e. Timelines as mentioned in the Annexure 1 will be considered for reckoning delivery.</p> <p>Penalty amount so determined along with applicable GST (for Indigenous orders) thereon shall be recovered.</p> <p>Imposition, recovery or settlement of this penalty shall not affect BHEL's right to performance, compensation and termination of the order.</p>		
14	<p>Excess materials supplied beyond tolerance limit as specified in PO will not be paid and bidder may raise credit note for the excess/unaccepted material as per GST law.</p>		<p>Non Deviatable</p>
15	<p>Rejected materials, if any, shall be collected by the bidder within 90 days of such communication to the bidder. Beyond this period the bidder forfeits their right to the materials.</p>		<p>Non Deviatable</p>
16	<p>Guarantee / Warranty Period:</p> <p>Wherever required, and so provided in the specifications/SCC/Purchase Order, the bidder shall guarantee that the goods supplied shall comply with the specifications laid down, for materials, workmanship and performance.</p> <p>a. Guarantee period shall be 12 months from the date of commissioning or 18 months from the date of supply whichever is earlier.</p> <p>b. In case erection & commissioning is involved, guarantee period shall be 12 months from the date of commissioning.</p> <p>c. In case of equipment bought as a package which are intended to be incorporated in installations or systems, the guarantee period shall be 12 months from the date of commissioning of such equipment.</p> <p>The guarantee period shall be extended by the period during which the goods are not in compliance. If the delivery is found to be non-complaint, bidder shall replace, repair or re-execute the as requested by BHEL. If the bidder defaults on his obligations, buyer has the right to proceed to replace, repair or re-execute at the bidder's expense.</p> <p>A guarantee period as described above shall apply afresh to replaced, repaired or re-executed parts of a delivery.</p> <p>Loading for deviation:</p> <p>In case warranty specified in SCC is over and above the period mentioned in b & c above; loading will be 1% per annum for the deviation in warranty end period, on the contract value. Expected commissioning period is as indicated in SCC.</p>		<p>Non Deviatable</p>
17	<p>PERFORMANCE BANK GUARANTEE (PBG) (Applicable in case mentioned in SCC)</p> <p>In case enquiry specifically spells out PBG requirement, PBG is to be submitted by Bidder in requisite format as per Annexure VII.</p> <p>Further detailing on PBG as specified in SCC.</p> <p>The PBG shall be for the performance of the goods and shall remain binding notwithstanding such variations, alterations or extensions of item as may be made, give, conceded or agreed to between the Bidder and BHEL under these Terms and conditions or otherwise.</p>		<p>Non Deviatable</p>
<p>NOTE: Deviations (Commercial as well as Technical) from the tender specifications and conditions are generally not acceptable. However, deviation if any, shall be brought out clearly with proper justification in the offer. The deviation, if considered by BHEL, shall be loaded for comparison, while evaluating the offer. If a bidder unconditionally withdraws any deviation before price bid opening, the same shall not be loaded. Loading criteria in respect of major commercial conditions where deviations if any are accepted shall be as per clause No.18. The Bidders may specifically note the following.</p>			
18	<p>Evaluation and Loading Criteria:</p>		

- i) Evaluation Currency for this tender shall be "INR".
 ii) Evaluation of prices shall be done item-wise unless otherwise specified in the SCC.
 iii) Evaluation shall be on the basis of delivered cost, i.e. "Total Cost to BHEL" w.r.t the finalized technical scope and commercial conditions (after considering incidence of applicable taxes and duties and loading).
 iv) In the course of evaluation, if more than one Bidder happens to occupy L1 status, effective L1 will be decided by soliciting discounts from the respective L1 Bidders. In case more than one Bidder happens to occupy the L1 status even after soliciting discounts, the L1 Bidder shall be decided by a toss/draw of lots, in the presence of the respective L1 Bidders or their representatives. Ranking will be done accordingly. BHEL decision in such situations shall be final and binding.

INDIGENOUS

- a. Bidder shall ensure to indicate the applicable taxes against each line item, failing which the same will be considered as inclusive/NIL.
 b. Ex-works offers received (as against FOR Destination mentioned in enquiry) shall be loaded by 2% of Ex-works value.
 c. GST and any other charges quoted will be added to the base price. However, in case input credit is available for GST (SGST, CGST/IGST), the same shall be excluded for arriving at "Total Cost to BHEL"

IMPORTS

For evaluation of offers in foreign currency, exchange rate (TT selling rate of State Bank of India) as on the date of bid opening (Part-I, in case of two-part bids) shall be considered. If the relevant day happens to be a bank holiday, then the forex rate as on the previous bank (SBI) working day shall be taken.

In case of foreign Bidders, the quoted CIP price shall be loaded by the following factors to arrive at "Total Cost to BHEL":

- Import duty as applicable on the date of Part-I bid opening.

- Loading will be as per the table below

	Ex Works	FOB/FC A	CIF/CFR	CIP
Foreign Inland freight and insurance	2%			
Marine freight and marine insurance	3%	3%		
Destination Port handling charges	0.50%	0.50%	0.50%	
clearing charges & inland freight and insurance	2%	2%	2%	2%

COMMON LOADING FOR IMPORTS & INDIGENOUS that will be added for arriving the "Total Cost to BHEL"

A. Loading on Deviated Penalty clause shall be 10% or to the extent to which the bidder has opted for deviation.

B. Loading for payment terms as per clause 12 of ITB

C. Loading for deviation in Warranty & PBG as per clause 16,17.

- 19** Procurement directly from the manufacturers/ suppliers shall be preferred. However, no agent shall be allowed to represent more than one manufacturer/ supplier in the same tender. Moreover, either the agent could bid on behalf of the manufacturer/ supplier or the manufacturer / supplier could bid directly but not both. In case bids are received from both from the manufacturer/ supplier and the agent, bid received from the agent shall be ignored.
- 20** **RIGHT OF REJECTION /NON- PLACEMENT OF PO:** BHEL reserves the right to accept or reject any or all bid/s in full or part without assigning any reason whatsoever.
- 21** **INTEGRITY PACT**
 Bidders shall have to enter into Integrity Pact with BHEL as per Annexure VI - for Tender value of rupees two crores and above and shall be signed by the authorized signatory along with the offer, failing which Bidder's offer will be rejected.
- 22** **Public Procurement**
- A** **Make in India**
 For this Procurement, the local content to categorize a bidder as a Class I local bidder / Class II local bidder / Non-Local bidder and purchase preference to Class I local bidder, is as defined in Public Procurement (Preference to Make in India) order No P-45021/2/2017-PP(BE-II) dated 04-06-2020 issued by DPIIT as amended from time to time.
 Proforma for self-certification for minimum local content and auditor's certification is given in Annexure III.
- B** Any Bidder from a country which shares a land border with India will be eligible to bid in this tender only if the bidder is registered with competent authority. GOI website <https://www.mea.gov.in/> to be referred for latest details of competent authority and exemptions .
 Proforma for self-certification for compliance is given in Annexure IV.
- C** **Startups:**
 For Start-ups duly registered with DPIIT (Copy of certificate to be provided), condition of prior turnover and prior experience in Public Procurement may be relaxed subject to meeting of Quality and Technical Specifications. Startups are exempt from paying EMD.
- 23** **Benefits earmarked for Purchase from Micro & Small Enterprises (MSEs) – Indigenous Purchase**
- A** All Micro and Small Enterprises (MSEs) as defined in MSE Procurement Policy are exempt from Paying EMD.
 NSIC/UDYAM registered bidders shall submit NSIC/UDYAM Certificate along with bid documents. Date to be reckoned for determining the deemed validity will be the last date of Technical bid submission. Non- submission of such document will lead to consideration of their bid, at par with other bidders and MSE status of such bidders shall be shifted to Non- MSE Category till the bidder submits these documents.



B	In tender, MSEs quoting price within price band of L1+15% shall also be allowed to supply a portion of requirement by bringing down their price to L1 price in a situation where L1 price is from someone other than a MSE and such MSE shall be allowed to supply at least 25% of total tendered value. In case of more than one such MSE, the supply shall be shared proportionately. Out of these 25% minimum 3% shall be earmarked for MSEs owned by women and 6.25% for MSEs owned by SC/STs who submit the relevant documents.
C	If an enterprise falling under MSME category as defined in the Act, graduates to a higher category from its original category or beyond the purview of the Act, it shall continue to avail all non-tax benefits of its original category notified by the Ministry of Micro, Small and Medium Enterprise for a period of three years from the date of such graduation to the higher category.
D	BHEL HPEP is registered with RXIL (TReDS) platform. MSME bidders are requested to get registered with RXIL (TReDS) platform to avail the facility as per the GOI guidelines.
24	Inspection Measuring and Test Equipment (IMTE) used by the Bidder/ Contractor or sub-contractor shall be calibrated, maintained and controlled. Calibration shall be valid and IMTE maintained in sound condition during usage.
25	ISO-9001, ISO14001 & OHSMS 45001 shall be complied.
26	If BHEL registered supplier is not quoting against this NIT, supplier shall send regret letter positively with valid reasons for not participating. Repeated lack of response on the part of supplier may lead to deletion of such registered supplier from BHEL's approved supplier's list as per BHEL SEARP Guidelines.
27	Risk Purchase clause: In case bidder fails/delays to supply whole or part of the ordered items or supplies defective items or fails to fulfil any other terms and conditions given in Purchase Order/Contract, BHEL has the right to terminate the order/contract or withdraw balance scope of work/supply and make the purchase of such material / services from elsewhere at the risk and cost of the defaulted bidder. The bidder is liable for the additional expenditure / difference in Cost, if any, including consequential losses which BHEL may sustain by reason of risk purchase in addition to the applicable LD as per the order/contract. Non-performance of contract attracts penal provisions in line with BHEL guidelines for Suspension of Business Dealings (SBD). Risk and Cost Calculation is enclosed at Annexure-C.
28	Any other terms and conditions of the bidder attached / referred against the tender enquiry will not be considered.
29	All drawings, patterns and tools supplied by BHEL or made at BHEL's expense are BHEL's property. These cannot be used or referred to any other party and must be used only in the execution of BHEL's orders.
30	Any amount payable by the bidder under any of the conditions of this contract shall be liable to be adjusted against any amount payable to the bidder under any other work / contract awarded by BHEL HPEP or any other BHEL Units. This is without prejudice to any other action as may be deemed fit by BHEL.
31	The bids of the bidders who are on the banned list and also the bids of the bidders, who engage the services of the banned firms, will be rejected. The list of firms banned by BHEL is available on BHEL web site: www.bhel.com
32	Ordering and confirmation of order The bidder shall send the order acceptance within one week from the date of LOI/Purchase order or such other period as specified/agreed by the Buyer. Buyer reserves the right to revoke the order placed if the order confirmation differs from the original order placed. Buyer shall be legally bound, only if agreed for any deviation explicitly in writing. The acceptance of deliverables or supplies by Buyer as well as payments made in this regard shall not imply acceptance of any deviations. The Purchase order will be deemed to have been accepted if no communication to the contrary is received within one week (or the time limit as specified /agreed by the Buyer) from the date of P.O. Buyer, is at liberty to send signed P.O. through electronic media such as e-mail and the receipt of which shall be treated as receipt of order.
33	Execution The whole contract is to be executed in the most workman like manner, substantial and approved as per the contracted terms.
34	Progress Report The bidder shall render such report as to the progress of work and in such form as may be called for by the Buyer from time to time. The submission and acceptance of such reports shall not prejudice the rights of the buyer in any manner. Bidder shall communicate to BHEL immediately, the change of address, ownership, contact person(s), the mobile numbers and e-mail of the dealing person concerned. Milestones shall be periodically updated by bidder through PRADAN Portal (https://hpep.bhel.com/mm/). Non updation will adversely affect service rating of bidder performance.
35	Non-disclosure Obligations

	<p>Drawings, technical documents or other technical information received by one party shall not without the consent of the other party, be used for any other purpose than that for which they were provided. They may not, without the consent of the submitting party, otherwise be used or copied, reproduced, transmitted or communicated to third parties. All information and data contained in general product documentation, whether in electronic or any other form, are confidential and binding only to the extent that they are by reference expressly included in the contract.</p> <p>The bidder shall, as per agreed date/s but not later than the date of delivery, provide free of charge any information and/or drawings which are necessary to permit the Buyer to erect, commission, operate and maintain the product. Such information and drawings shall be supplied as specified in technical specification.</p> <p>All intellectual properties, including designs, drawings and product information etc. exchanged during the formation and execution of the contract shall continue to be the property of the submitting party.</p> <p>The bidder shall provide Buyer with all information pertaining to the delivery in so far as it could be of importance to Buyer. The bidder shall not reveal confidential information to its own employees not involved with the tender/contract and its execution and delivery or to third parties, unless Buyer has agreed to this in writing beforehand. The bidder shall not be entitled to use the Buyer's name in advertisements and other commercial publications including website without prior written permission from Buyer.</p> <p>In the event of violation of the confidentiality as agreed, BHEL will take legal action as deemed fit. Non-disclosure agreement to be entered as per Annexure- II wherever applicable.</p>
36	Inspection and Testing
A	The goods and stores shall be manufactured by approved quality system and each part/component may be inspected and tested by the Buyer prior to shipment and shall comply with relevant requirements. Buyer has the right to inspect at any stage during manufacture/ delivery.
B	<p>Buyer or his authorized representative shall be entitled at all reasonable times during execution to inspect, examine and test at the bidder's premises the material and workmanship of all stores to be supplied under the contract, and if the part of the stores are being manufactured at other premises, the bidder shall obtain for buyer or his authorized representative permission to inspect, examine and test as if the said stores are being manufactured at the bidder's premises. Such inspection, examination and testing, if made shall not release the bidder from any obligation under the contract.</p> <p>For indigenous bidders all costs related to first inspection request shall be borne by the buyer and the cost of subsequent inspections due to non-readiness of material/rework/ rejections shall be borne by the bidder. In case of imports all inspection charges including third party inspections if any shall be borne by the bidder. The cost of inspection staff/third party specified by the Buyer shall be borne by bidder unless otherwise specifically agreed. If the contract provides for tests on the premises of the bidder or any of his sub-contractor/s, bidder shall be responsible to provide such assistance, labor, materials, electricity, fuels, stores, apparatus, instruments as may be required and as may be reasonably demanded to carry out such tests efficiently. Cost of any type test or such other special tests shall be borne by the bidder unless otherwise specifically agreed in the contract. The Bidder shall give the authorized representative of the buyer reasonable notice in writing of the date on and the place at which any stores will be ready for inspection/ testing as provided in the Contract. Annexure – I, may strictly be complied with for the time lines. Any delay in submission of the documents by the bidder will not alter the delivery date.</p>
37	Quality and Condition of the Deliverables
	The bidder shall be responsible for compliance with applicable technical, safety, quality, environmental requirements and other regulations in relation to products, packaging and raw and ancillary materials.
38	Packaging and Dispatch
	<p>The bidder shall package the deliverables safely and carefully and pack them suitably in all respects considering the peculiarity of the material for normal safe transport by sea/air/rail/road to its destination suitably protected against loss, damage, corrosion in transit and the effect or tropical salt laden atmosphere. The packages shall be provided with fixtures/hooks and sling marks as may be required for easy and safe handling by mechanical means. Special packaging conditions/ environmental conditions as defined in the NIT shall be fully complied.</p> <p>Each package must be marked with consignee name, address, P.O. number, Package Number, gross weight & net weight, dimensions (Lx B x H) and bidder's name. The packing shall allow for easy removal and checking of goods on receipt and comply with carrier's conditions of packing or established trade practices. Packing list for goods inside each package with P.O. item No. & quantity must also be fixed securely outside the box to indicate the contents. If any consignment needs special handling instruction, the same shall be clearly marked with standard symbols/instructions. Hazardous material should be notified as such and their packing, transportation and other protection must conform to relevant regulations.</p>
39	Contract variations; Increase or decrease in the scope of supply
	<p>Buyer may vary the contracted scope during execution due to exigencies of project requirement.</p> <p>If the bidder is of the opinion that the variation has an effect on the agreed price or delivery period, Buyer shall be informed of this immediately in writing along with technical details, and in the event of additional work, submit a quotation with regards to the price and period involved, as well as the effect this additional work will have on the other work to be performed by the bidder. Wherever unit rates are available in the contract, the same shall be applied to such additional work. The bidder shall not perform additional work before buyer has issued written instructions/amendment to the purchase order to that effect. The work which the bidder should have or could have anticipated in terms of delivering the service (s) and functionality (ies) as described in this agreement should be executed by the bidder without any price implication.</p> <p>In case of no change in the scope / technical specifications, bidder shall endeavor to keep the material ready and intimate the same to BHEL within the contractual delivery date, failing which, the delay if any will be attributed to supplier, and any upward price variation thereof for delivery at a later date is not admissible.</p>
40	Rejected/Short shipments/ warranty/guarantee replacements
	In case of any short shipment during initial supply which is subsequently dispatched by the bidder or any guarantee / warranty replacements shall be dispatched on "DDP-Delivered duty paid BHEL stores" basis for imported items and "FOR-BHEL Stores/designated destination" basis for indigenous items.
41	Export Administration Regulations
	If a delivery includes such technology and / or supply that is subjected to the export regulations the bidder shall obtain due permissions, approvals, license etc.
42	Force Majeure

	<p>The bidder shall not be considered in default if delay occurs due to causes beyond their control such as Acts of God, Natural calamities, Fire, Frost, Flood, Civil War, civil commotion, riot, Government Restrictions.</p> <p>Only those causes that have duration of more than seven days shall be considered cause of force majeure. Notification to this effect duly certified by local chamber of commerce/statutory authorities with supporting documents shall be given by the bidder to BHEL by registered letter/courier service immediately without loss of time.</p> <p>In the event of delay due to such causes the delivery schedule shall be extended for a length of time equal to the period of Force Majeure or at the option of BHEL the order may be cancelled. Such cancellation would be without any liability whatsoever on the part of BHEL.</p> <p>In the event of such cancellation the bidder shall refund any amount advanced or paid to the bidder by BHEL and deliver back any material issued to him by BHEL and release facilities, if any provided by BHEL.</p>
43	<p>Non-waiver of Defaults</p> <p>If any individual provision of the contract is invalid, the other provisions shall not be affected.</p>
44	<p>Settlement of Disputes</p> <p>Except as otherwise specifically provided in the contract, all disputes concerning questions of the facts arising under the contract, shall be decided by the Buyer, subject to written appeal by the bidder to the buyer, whose decision shall be final.</p> <p>Any disputes of differences shall to the extent possible be settled amicably between the parties thereto, failing which the disputed issues shall be settled through arbitration</p> <p>The bidder shall continue to perform the contract, pending settlement of disputes(s).</p>
45	<p>Conciliation clause</p> <p>CONCILIATION CLAUSE FOR CONDUCTING CONCILIATION PROCEEDINGS UNDER THE BHEL CONCILIATION SCHEME, 2018: The Parties agree that if at any time (whether before, during or after the arbitral or judicial proceedings), any Disputes (which term shall mean and include any dispute, difference, question or disagreement arising in connection with construction, meaning, operation, effect, interpretation or breach of the agreement, contract or the Memorandum of Understanding, penalty deduction, time extension), which the Parties are unable to settle mutually, arise inter-se the Parties, the same may, be referred by either party to Conciliation to be conducted through Independent Experts Committee to be appointed by competent authority of BHEL from the BHEL Panel of Conciliators.</p> <p>The proceedings of Conciliation shall broadly be governed by Part-III of the Arbitration and Conciliation Act 1996 or any statutory modification thereof and as provided in Procedure in http://www.bhel.com/index.php/story_details?story=2454 . The Procedure together with its Formats will be treated as if the same is part and parcel hereof and shall be as effectual as if set out herein in this ITB</p>
46	<p>ARBITRATION (WITH SOLE ARBITRATOR)</p> <p>Except as provided elsewhere in this Contract, in case amicable settlement is not reached between the Parties, in respect of any dispute or difference; arising out of the formation, breach, termination, penalty deduction, validity or execution of the Contract; time extension, or, the respective rights and liabilities of the Parties; or, in relation to interpretation of any provision of the Contract; or, in any manner touching upon the Contract, then, either Party may, by a notice in writing to the other Party refer such dispute or difference to the sole arbitration . Sole arbitrator to be appointed by Head of the Unit - BHEL , HPEP .</p> <p>The Arbitrator shall pass a reasoned award and the award of the Arbitrator shall be final and binding upon the Parties.</p> <p>Subject as aforesaid, the provisions of Arbitration and Conciliation Act 1996 (India) or statutory modifications or re-enactments thereof and the rules made thereunder and for the time being in force shall apply to the arbitration proceedings under this clause. The seat of arbitration shall be Hyderabad, Telangana. The language of arbitration shall be English and the documents shall be submitted in English.</p> <p>The cost of arbitration shall initially be borne equally by the Parties subject to the final apportionment of the cost of the arbitration in the award of the Arbitrator.</p> <p>Subject to the arbitration in terms of clause 46, the courts at Sangareddy, Telangana State shall have exclusive jurisdiction over any matter arising out of or in connection with this contract.</p> <p>Notwithstanding the existence or any dispute or differences and/or reference for the arbitration, the Contractor shall proceed with and continue without hindrance the performance of its obligations under this Contract with due diligence and expedition in a professional manner except where the Contract has been terminated by either Party in terms of this Contract.</p>
	<p>ARBITRATION FOR CONTRACT WITH PUBLIC SECTOR ENTERPRISE (PSE) OR A GOVERNMENT DEPARTMENT</p> <p>In the event of any dispute or difference relating to the interpretation and application of the provisions of commercial contract(s) between Central Public Sector Enterprises (CPSEs/ Port Trusts inter se and also between CPSEs and Government Departments/Organizations (excluding disputes concerning Railways, Income Tax, Customs & Excise Departments), such dispute or difference shall be taken up by either party for resolution through AMRCD as mentioned in DPE 0M No 4(1)/2013-DPE(GM/FTS 1835 dated 22-05-2018</p>
47	<p>Applicable Laws and jurisdiction of Courts</p> <p>This agreement shall be construed and interpreted in accordance with the laws of India and shall have exclusive jurisdiction of Sangareddy courts, Telangana, India.</p>
48	<p>BHEL-Fraud prevention policy shall be adhered to.</p> <p>The Bidder along with its associate/ Collaborators/ Sub-contractors/ sub-bidders/ consultants/ service providers shall strictly adhere to BHEL Fraud Prevention policy displayed on BHEL Website http://www.bhel.com and shall immediately bring to the notice of BHEL management about any fraud or suspected fraud as soon as it comes to their notice.</p> <p>List of nodal officers is hosted on BHEL Hyderabad website https://hpep.bhel.com/.</p>
49	<p>Suspected Cartel Formation</p> <p>The Bidder declares that they will not enter into any illegal or undisclosed agreement or understanding, whether formal or informal with other Bidder(s). This applies in particular to prices, specifications, certifications, subsidiary contracts, submission or non-submission of bids or any other actions to restrict competitiveness or to introduce cartelization in the bidding process. In case , the Bidder is found having indulged in above activities, suitable action shall be taken by BHEL as per extant policies / guidelines .</p>
50	<p>Conflict of Interest:</p> <p>"A bidder shall not have conflict of interest with other bidders. Such conflict of interest can lead to anti-competitive practices to the detriment of Procuring Entity's interests. The bidder found to have a conflict of interest shall be disqualified. A bidder may be considered to have a conflict of interest with one or more parties in this bidding process, if:</p>



- a) they have controlling partner (s) in common; or
b) they receive or have received any direct or indirect subsidy/ financial stake from any of them; or
c) they have the same legal representative/agent for purposes of this bid; or
d) they have relationship with each other, directly or through common third parties, that puts them in a position to have access to information about or influence on the bid of another Bidder; or
e) Bidder participates in more than one bid in this bidding process. Participation by a Bidder in more than one Bid will result in the disqualification of all bids in which the parties are involved. However, this does not limit the inclusion of the components/ sub-assembly/ Assemblies from. one bidding manufacturer in more than one bid; or
f) In cases of agents quoting in offshore procurements, on behalf of their principal manufacturers, one agent cannot represent two manufacturers or quote on their behalf in a particular tender enquiry. One manufacturer can also authorize only one agent/dealer. There can be only one bid from the following:
1. The principal manufacturer directly or through one Indian agent on his behalf; and
2. Indian/foreign agent on behalf of only one principal; or
g) A Bidder or any of its affiliates participated as a consultant in the preparation of the design or technical specifications of the contract that is the subject of the Bid; or
h) In case of a holding company having more than one independently manufacturing units, or more than one unit having common business ownership/management, only one unit should quote. Similar restrictions would apply to closely related sister companies. Bidders must proactively declare such sister/ common business/ management units in same/ similar line of business. "

Note: Purchase officer has to fill Annexure-I while sending enquiry

Annexure-C

STANDARD OPERATING PROCEDURE (SOP) FOR IMPLEMENTATION OF RISK & COST OPTION ON NON-PERFORMING and/ or DEFAULTING CONTRACTORS/ SUPPLIERS

Risk and Cost against Balance Work:

$$\text{Risk \& Cost Amount} = [(A-B) + (A \times H / 100)]$$

Where,

A= Value of Balance scope of Work/ Supply (*) as per rates of new contract

B= Value of Balance scope of Work/ Supply (*) as per rates of old contract being paid to the contractor/ supplier at the time of termination of contract i.e. inclusive of PVC & ORC, if any.

H = Overhead Factor to be taken as 5

In case (A-B) is less than 0 (zero), value of (A-B) shall be taken as 0 (zero).

Annexure-I**Major Activity Timelines shall be considered**

S.No.	Activity	Agency	Timeline
1	PO Acknowledgement	Vendor	<u>7 Days</u> from PO Date
2	Raising of Inspection Call with BHEL TPIA	Vendor	<u>7 Days</u> prior to Inspection date
3	Readiness of material for dispatch (for indigenous)	Vendor	<u>15 Days</u> prior to PO Delivery Date
4	Despatch Instructions	BHEL	<u>3 Days</u> from the date of receipt of Final Inspection report (BHEL TPIA and End Customer).
5	Receipt of material	Vendor	<u>10 Days</u> from Dispatch Instructions.

(To be executed on Non- Judicial Stamp Paper for an appropriate value.

To be stamped as an agreement)

(For Suppliers on Unit's / Division's PMD)

ANNEXURE-II

Framework Confidentiality Agreement Cum Undertaking

This Agreement made on this the _____ day of (month) _____ 20 ____ ("Effective Date") by and between M/s. BHARAT HEAVY ELECTRICALS LIMITED, having registered office at "BHEL House", Siri Fort, New Delhi – 110049 (India), acting through its _____ Unit (hereinafter may be referred to as "BHEL" or "the company").

And

M/s. _____ (address) _____
represented by authorized representative Sri _____ (herein after referred to as the "Supplier").

The supplier and the company may, unless the context otherwise requires, hereinafter be collectively referred to as "Parties" or singly as the "Party".

RECITALS

Whereas, BHEL is engaged in the design, engineering, manufacturing, construction, testing, commissioning and servicing of a wide range of products, systems and services for the core sectors of the economy, viz. Power, Transmission, Industry, Transportation, Renewable energy, Oil & Gas and Defence and providing associated services to varied customers in relation to which BHEL / its affiliates own valuable information of a secret and confidential nature.

Whereas the Company may, in connection with contract(s) (as defined hereunder) placed or to be placed upon the supplier, or otherwise, from time to time, make available, Technical Information as is defined hereunder.

And Whereas BHEL is willing to provide such Technical Information to the Supplier from time to time and the Supplier understands and acknowledges that such Technical Information is valuable for the Company and as such is willing to protect confidentiality of such information, subject to the terms and conditions set out hereunder.

Now therefore, in view of the foregoing premises and in consideration of the mutual covenants and agreements hereinafter set forth, the parties agree as under:

1. Definitions:

Unless the context so requires, in this Agreement, the following terms will bear the meaning ascribed to the said term in this clause.

- A. **“Contract”** means the contract entered into with a supplier and includes a Purchase Order, or a Work Order for procurement of any goods or for provision of any services.
- B. **“Effective Date”** means the date of this Agreement as mentioned in the preamble of this Agreement.
- C. **“Supplier”** includes a Contractor or a Vendor of the Company whether for supplying of goods or for providing any services under a Contract or both.
- D. **“Technical Information”** includes Drawings, and / or Product Standards and / or Specifications and / or Corporate / Plant Specifications and / or Technological Process Sheets and / or Technical Data Sheets and / or Jigs & Fixtures and / or Pattern & Dies and / or Special Gauges and / or Tools etc. Belonging to or wherein the Company has acquired from a third party a right of user and includes any improvement thereto from time to time whether carried out by the Company or by the Suppliers.
- E. **“Intended Purpose”** means the purpose for which the Technical Information is provided to the supplier under or in connection with a contract.
- F. **“Improvement”** includes any modification made to, or adaptation of, the Technical Information which enhances or is calculated to enhance the performance (Whether in terms of effectiveness or in terms of efficiency or both) of the product and / or the service to be provided by the Supplier under a Contract.

2. This Agreement shall come into force / deemed to have come into force, as the case may be, on the Effective Date; or, on the first date when the Technical Information or any part thereof is provided by BHEL to the supplier; whichever is earlier.

3. **Agreement deemed to be incorporated in each contract:** Unless and to the extent otherwise stipulated in the Contract, the conditions of this Agreement are deemed to be incorporated in all Contracts which may be entered into between the Company and the Supplier. Further, unless otherwise stipulated, the obligations under this Agreement are and will be independent of the obligations under the Contracts and such obligations of the Supplier hereunder will remain of full effect and validity notwithstanding that the period of validity of the Contract has expired by efflux of time stipulated therein; or, the contract has been discharged by performance or breach; or, the termination of the Contracts for any reason whatsoever.

4. **Ownership:**

4.1 The Company may, from time to time, make available to the Supplier, Technical Information on a non-exclusive basis by way of loan.

4.2 The Supplier acknowledges and agrees that all Technical Information and copies thereof that are or may be provided by the Company to the Supplier, are and shall remain the property of

BHEL or that of the concerned entity from whom BHEL has obtained the Technical Information and such Technical Information are and shall constitute trade secrets of the BHEL. Nothing in this Agreement or in any disclosures made hereunder by or on behalf of the Company shall be construed as granting upon the Supplier any patent, copyright or design or any other intellectual property rights of whatsoever description that subsists or may hereinafter exist in the Technical Information. Furthermore, nothing in this Agreement or in any disclosures made hereunder by or on behalf of the Company shall be construed as granting upon the supplier any license or right of use of such patent, copyright or design or any other intellectual property rights of whatsoever description which may now or hereafter exist in the Technical Information except for use of the Technical Information strictly in accordance with this Agreement and the contract and / or as directed in writing by the Company, solely for the Intended Purpose under the Contract.

4.3 Neither party is obligated by or under this Agreement to purchase from or provide to the other party any service or product and that any such purchase / sale of any product and / or service by one party to the other party will be governed by the Contract if any, that may be entered into by and between the Company and the Supplier.

4.4 The Supplier is / has been made well aware and acknowledges that the Technical Information being / which may be shared with it by the Company has been either generated by the Company by incurring huge investment and cost or obtained from foreign collaborators under Technical Collaboration Agreement (TCA) with stringent confidentiality conditions.

4.5 The supplier agrees and undertakes to adhere to confidentiality requirements as applicable to BHEL under a TCA and also ensure that the confidentiality requirements are adhered to by all its concerned employees or sub-contractors /suppliers (where permitted to be engaged by BHEL). Any damages, losses, expenses of any description whatsoever, arising out of or in connection with a breach of the confidentiality requirements under a TCA owing to any act or omission on the part of the supplier or its employees or sub-contractors / suppliers that is claimed by a foreign collaborator from the Company shall be wholly borne by the Supplier and it shall keep BHEL fully indemnified in this behalf. The demand by the Company shall be conclusive upon the Supplier who shall thereupon forthwith pay to the Company without demur, dispute or delay the amount as demanded without demanding any further proof thereof.

4.6 The Supplier agrees and undertakes that unless so decided and advised by the Company in writing all rights / title to any Improvement to the Technical Information shall vest in the Company. The Supplier undertakes and agrees to inform forthwith to the Company of any such Improvement made to the Technical Information and transfer all drawings / documents or other materials connected with such Improvement to the Company and also agrees to fully cooperate with the Company for protecting the Company's interests in such Improvements

in the Technical Information including but not limited to obtaining necessary protection for the intellectual property rights in such improvement, if so desired by the Company. If a question arises whether a modification amounts to improvement to the Technical Information, the same shall be decided by the Company and such decision shall be final and binding upon the supplier.

5. Use and Non – Disclosure:

5.1 Unless otherwise stipulated by the Company, all Technical Information made available to the supplier, by the Company shall be treated as Confidential irrespective of whether the same is marked or otherwise denoted to be Confidential or not.

5.2 The Supplier undertakes and agrees that the Technical Information in its possession shall be held in strict confidence and will be used strictly in accordance with this Agreement and solely for the Intended Purpose under the Contract. Use of the Technical Information for any other purpose other than Intended Purpose is prohibited.

5.3 In particular, the Supplier shall not use Technical Information or any Improvement in its possession for the manufacture or procurement of the product(s) or components or parts thereof or use the Technical Information or any portion thereof or any modification or adaptation thereof in any form to provide any product and / or service to any third party, without the prior written consent of the Company.

5.4 The Supplier shall not disclose any of such Technical Information to any third party without the prior written consent of the Company. The Supplier agrees that without prior written consent of the Company, the supplier shall not disclose to a third party about the existence of this Agreement, or of the fact that it is / was in possession of or has experience in the use of any Technical Information nor shall the Supplier share in any manner whatsoever, with a third party, the name or details of any Contract(s) awarded by the Company to it or performed by the Supplier or the scope of work thereof or share any document or correspondence by and between the Company and the supplier in or in connection with this Agreement or such Contract(s). Notwithstanding what is stated elsewhere, the overall responsibility of any breach of the confidentiality provisions under this Agreement shall rest with the Supplier.

5.5 This Supplier undertakes and agrees not to make copies or extracts of and not to disclose to other any or all of the Technical Information in its possession, except as follows:

(a) The Supplier may disclose the Technical Information to such of its officers and employees strictly to the extent as is necessary for such officer or employee for the Intended Purpose, provided that the Confidential Information (or copies thereof) disclosed shall be marked

clearly as the confidential and proprietary information of Company and that such officers and employees shall similarly be bound by undertakings of confidence, restricted use and non-disclosure in respect of the Technical Information. The Supplier shall be responsible for any breach of such confidentiality provisions by such officers and employees.

- (b) With the prior written consent of Company, the supplier may disclose for the Intended Purpose such Technical Information as is provided for in such consent to such of its professional advisers: consultants, insurers and subcontractors who shall be similarly bound by undertakings of confidence, restricted use and non-disclosure in respect of such Technical Information.
- (c) The Supplier shall not be prevented to make any disclosure required by (i) order of a court of competent jurisdiction or (ii) any competent regulatory authority or agency where such disclosure is required by law, provided that where the supplier intends to make such disclosure, it shall first consult Company and take all reasonable steps requested by it to minimize the extent of the Technical Information disclosed and to make such disclosure in confidence and also shall cooperate with the Company in seeking any protective order or any other remedy from proper authority in this matter.

6. Exceptions:

The Obligations of the Supplier pursuant to the provisions of this agreement shall not apply to any Confidential Information that:

- a) was / is known to, or in the possession of the Supplier prior to disclosure thereof by the Company;
- b) is or becomes publicly known, otherwise than as a result of a breach of this agreement by the Supplier.
- c) is developed independently of the Disclosing party by the Supplier in circumstances that do not amount to a breach of the provisions of this Agreement or the Contract;
- d) is received from a third party in circumstances that do not result in a breach of the provisions of this Agreement.

- 7. The Obligation of maintaining confidentiality of the Technical Information on each occasion, shall subsist for the entire duration during which the Technical Information / equipment is in possession of the Supplier and shall thereafter subsist for a further period of _____ years from the date when the complete Technical Information has been returned in portions on different dates, the period of ____ years will be reckoned from the date when the last portion of the Technical Information has been returned. Notwithstanding the expiry of the confidentiality obligation, the obligation of the Supplier under clause 5.4 shall continue to subsist for a further period of _____ years.

8. Warranties & Undertakings:

- a) The Supplier undertakes to ensure the due observance of the undertakings of confidence, restricted use and non-disclosure by its persons to whom it discloses or releases copies or extracts of the Technical Information.
- b) The Supplier shall keep the Technical Information or improvement made therein properly segregated and not mix up the same with any other material / documents belonging to him / it or to any other third party.
- c) The Supplier further undertakes that he / it shall not hypothecate or give on lease or otherwise alienate or do away with any of the Technical Information and / or equipment of the Company, made available to him / it, and undertakes that he / it shall hold the same as a trustee, in capacity of custodian thereof and use / utilise the same solely for the purpose of executing the contract awarded by the Company.
- d) The Supplier further undertakes that he / it shall return all the equipment and / or Technical Information as far as practicable in the same condition in which the same was made available to him / it by the Company together with any Improvement thereon and the documents connected with such Improvement, to the Company forthwith upon completion of the scope of work or contract for which such Technical Information was provided by the Company to it or as directed by the Company together with a confirmation by way of an affidavit or in such manner as directed by the Company that it has not retained any equipment and / or Technical Information / improvement thereof. In case any such equipment and / or Technical Information or thereof shall remain in his possession or is not capable of being returned, the retention and use of such Technical Information or improvement thereto shall continue to be governed by this Agreement.
- e) The Supplier undertakes to indemnify the Company for all the direct, indirect and / or consequential losses, damages, expenses whatsoever including any consequential loss of business, profits suffered by the Company owing to breach by the Supplier of its obligations under this Agreement and / or the confidentiality requirements, if any, contained in the Contract and that the Supplier hereby agrees that the decision of the Company in all such or any such matter/s shall be final and binding on the Supplier. On mere written demand of the Company, the Supplier shall forthwith and without demur or delay pay to the Company any such sum as determined by the Company as the amount of loss or damage or expense which has been suffered by the Company. The Supplier agrees that the Company shall be entitled to withhold and appropriate any amount payable to the Supplier under any Contract then existing between the Company and the Supplier, in case the Supplier fails to make payment, in terms of the written demand, within 7 days thereof. Without prejudice to the forgoing actions, in respect to any breach of this Agreement, the Company shall be entitled to take

any other action against the Supplier as per applicable laws, the Contract, Company's applicable policies, guidelines rules, procedures, etc.

9. Without prejudice to any other mode of recovery as may be available to the Company for recovery of the amount determined as due as per Clause 9 (f) hereinabove, the Company shall have a right to withhold, recovery and appropriate the amount due towards such losses, damages, expenses, from any amount due to the Supplier in respect of any other Contract (s) placed on him / it by any department / office / unit/ division of the said Company.

10. Arbitration & Conciliation:

Except as provided elsewhere in this Contract, in case amicable settlement is not reached between the Parties, in respect of any dispute or difference; arising out of the formation, breach, termination, penalty deduction, validity or execution of the Contract; time extension, or, the respective rights and liabilities of the Parties; or, in relation to interpretation of any provision of the Contract; or, in any manner touching upon the Contract, then, either Party may, by a notice in writing to the other Party refer such dispute or difference to the sole arbitration . Sole arbitrator to be appointed by Head of the Unit - BHEL, HPEP.

The Arbitrator shall pass a reasoned award and the award of the Arbitrator shall be final and binding upon the Parties.

Subject as aforesaid, the provisions of Arbitration and Conciliation Act 1996 (India) or statutory modifications or re-enactments thereof and the rules made thereunder and for the time being in force shall apply to the arbitration proceedings under this clause.

The seat of arbitration shall be Hyderabad, Telangana. The language of arbitration shall be English and the documents shall be submitted in English.

The cost of arbitration shall initially be borne equally by the Parties subject to the final apportionment of the cost of the arbitration in the award of the Arbitrator.

Subject to the arbitration in terms of clause 46 of ITB (clause 27 of ATC GeM), the courts at Sangareddy, Telangana State shall have exclusive jurisdiction over any matter arising out of or in connection with this contract.

Notwithstanding the existence or any dispute or differences and/or reference for the arbitration, the Contractor shall proceed with and continue without hindrance the performance of its obligations under this Contract with due diligence and expedition in a professional manner except where the Contract has been terminated by either Party in terms of this Contract.

ARBITRATION FOR CONTRACT WITH PUBLIC SECTOR ENTERPRISE (PSE) OR A GOVERNMENT DEPARTMENT

In the event of any dispute or difference relating to the interpretation and application of the provisions of commercial contract(s) between Central Public Sector Enterprises (CPSEs/ Port Trusts inter se and also between CPSEs and Government Departments/Organizations (excluding disputes concerning Railways, Income Tax, Customs & Excise Departments), such dispute or difference shall be taken up by either party for resolution through AMRCD as mentioned in DPE OM No 4(1)/2013-DPE(GM/FTS 1835 dated 22-05-2018

CONCILIATION CLAUSE FOR CONDUCTING CONCILIATION PROCEEDINGS UNDER THE BHEL CONCILIATION SCHEME, 2018: The Parties agree that if at any time (whether before, during or after the arbitral or judicial proceedings), any Disputes (which term shall mean and include any dispute, difference, question or disagreement arising in connection with construction, meaning, operation, effect, interpretation or breach of the agreement, contract or the Memorandum of Understanding, penalty deduction, time extension), which the Parties are unable to settle mutually, arise inter-se the Parties, the same may, be referred by either party to Conciliation to be conducted through Independent Experts Committee to be appointed by competent authority of BHEL from the BHEL Panel of Conciliators.

The proceedings of Conciliation shall broadly be governed by Part-III of the Arbitration and Conciliation Act 1996 or any statutory modification thereof and as provided in Procedure in http://www.bhel.com/index.php/story_details?story=2454 . The Procedure together with its Formats will be treated as if the same is part and parcel hereof and shall be as effectual as if set out herein in this ITB

11. Governing Law & Jurisdiction:

This agreement shall be construed and interpreted in accordance with the laws of India and shall have exclusive jurisdiction of Sangareddy courts, Telangana, India.

SIGNATURE

WITNESSES

1

Name:

Address:

2

Name:

Address:

Note:

- 1) The Stamp duty for Agreement is Rs. 200/- in Telangana State. However, the stamp duty at the place of execution/receiving whichever is higher should be paid.
- 2) Instrument executed outside India can be stamped within three months after it is first received in India.

Annexure - III

Proforma for self-certification by Supplier for minimum local content on their letter head for tender value less than Rs 10 Crore

"We _____ (Name of Manufacturer) undertake that we meet the mandatory minimum Local Content (LC) requirement i.e. _____ (to be filled as notified in the policy) for claiming Purchase Preference linked with Local Contents under the Govt. policy against tender no. _____."

Annexure - IV

Proforma for self-certification by Supplier for Compliance to Clause No 20 (B)

I have read the clause regarding restrictions on procurement from a bidder of a country which shares a land border with India and I certify that M/s.... (Name of firm) is **not from such a country/is from such a country** (delete whichever is NOT applicable) and has been duly registered with the Competent authority (delete if NOT applicable) . I hereby certify M/s fulfills all requirements in this regard and is eligible to be considered . (where applicable , valid registration by the competent authority shall be attached)

Sd/-

Authorised Signatory with Stamp

Annexure V

(On Company Letter Head)

FORM NO. 10F

[See sub-rule (1) of rule 21AB]

Information to be provided under sub-section (5) of section 90 or sub-section (5) of section 90A of the Income-tax Act, 1961

I..... son/daughter of Mr in the capacity of.....
(Designation) do provide the following information, relevant to the previous year **2021-22** in case of for the purposes of sub-section (5) of section 90/section 90A:-

Sl.No.	Nature of information	Details
(i)	Status (individual; company, firm etc.) of the assessee	Company
(ii)	Permanent Account Number (PAN) of the assessee if allotted	
(iii)	Nationality (in the case of an individual) or Country or specified territory of incorporation or registration (in the case of others)
(iv)	Assessee's tax identification number in the country or specified territory of residence and if there is no such number, then, a unique number on the basis of which the person is identified by the Government of the country or the specified territory of which the assessee claims to be a resident

(v)	Period for which the residential status as mentioned in the certificate referred to in sub-section (4) of section 90 or sub-section (4) of section 90A is applicable	<u>2022-23</u>
(vi)	Address of the assessee in the country or territory outside India during the period for which the certificate, mentioned in (v) above, is applicable

I have obtained a certificate to in sub-section (4) of section 90 of sub-section (4) of section 90A from the Government of..... (name of country or specified territory outside India)

Signature:.....

Name:.....

Address:.....

Email ID:.....

Contact Number.....

Permanent Account Number:.....

Verification

I..... do hereby declare that to the best of my knowledge and belief what is stated above is correct complete and is truly stated. Verified today the..... day of.....

In case the M/s Bharat Heavy Electricals Limited, HPEP, Ramachandrapuram, Hyderabad is declared as an assessee in default due to any misstatement or incorrect declaration, we indemnify M/s Bharat Heavy Electricals Limited from any ensuing consequences thereunder.

Signature of the person providing the information

Place:.....

(On Company Letter Head)

No Business Connection or Permanent Establishment Certificate

Date

To

Bharat Heavy Electricals Limited
Ramachandrapuram, Hyderabad
India - 502032

Sir,

Sub: No Business Connection or Permanent Establishment declaration for FY **2021-22**

This is to certify that (Name of the supplier) is a company incorporated in (country) and does not have any business connection in India as per the provision of Section 9 of the Income Tax Act 1961 or any Permanent Establishment as defined in Article 5 of the India and(country) DTAA.

We hereby certify that we will notify BHEL in case of any change in the status as certified above.

For

Authorised Signatory

(Note – Please refer definition of the Business Connection on reverse and Permanent Establishment in the relevant DTAA)

"Business connection" as defined in Section 9 of the Income Tax Act shall include any business activity carried out through a person who, acting on behalf of the non-resident,—

- (a) has and habitually exercises in India, an authority to conclude contracts on behalf of the non-resident or habitually concludes contracts or habitually plays the principal role leading to conclusion of contracts by that non-resident and the contracts are—
 - (i) in the name of the non-resident; or
 - (ii) for the transfer of the ownership of, or for the granting of the right to use, property owned by that non-resident or that non-resident has the right to use; or
 - (iii) for the provision of services by the non-resident; or
- (b) has no such authority, but habitually maintains in India a stock of goods or merchandise from which he regularly delivers goods or merchandise on behalf of the non-resident; or
- (c) habitually secures orders in India, mainly or wholly for the non-resident or for that non-resident and other non-residents controlling, controlled by, or subject to the same common control, as that non-resident:

Provided that such business connection shall not include any business activity carried out through a broker, general commission agent or any other agent having an independent status, if such broker, general commission agent or any other agent having an independent status is acting in the ordinary course of his business :

Provided further that where such broker, general commission agent or any other agent works mainly or wholly on behalf of a non-resident (hereafter in this proviso referred to as the principal non-resident) or on behalf of such non-resident and other non-residents which are controlled by the principal non-resident or have a controlling interest in the principal non-resident or are subject to the same common control as the principal non-resident, he shall not be deemed to be a broker, general commission agent or an agent of an independent status

For the removal of doubts, it is hereby clarified with explanation-2A, that the significant economic presence of a non-resident in India shall constitute "business connection" in India and "significant economic presence" for this purpose, shall mean—

- (a) transaction in respect of any goods, services or property carried out by a non-resident in India including provision of download of data or software in India, if the aggregate of payments arising from such transaction or transactions during the previous year exceeds such amount as may be prescribed; or
- (b) systematic and continuous soliciting of business activities or engaging in interaction with such number of users as may be prescribed, in India through digital means:

Provided that the transactions or activities shall constitute significant economic presence in India, whether or not,—

- (i) the agreement for such transactions or activities is entered in India; or
- (ii) the non-resident has a residence or place of business in India; or
- (iii) the non-resident renders services in India:

Thresholds for the purposes of significant economic presence.

11UD. (1) For the purposes of clause (a) of Explanation 2A to clause (i) of sub-section (1) of section 9, the amount of aggregate of payments arising from transaction or transactions in respect of any goods, services or property carried out by a non-resident with any person in India, including provision of download of data or software in India during the previous year, shall be two crore rupees;

(2) For the purposes of clause (b) of Explanation 2A to clause (i) of sub-section (1) of section 9, the number of users with whom systematic and continuous business activities are solicited or who are engaged in interaction shall be three lakhs.

INTEGRITY PACT**Between**

Bharat Heavy Electricals Ltd. (BHEL), a company registered under the Companies Act 1956 and having its registered office at "BHEL House", Siri Fort, New Delhi - 110049 (India) hereinafter referred to as "The Principal", which expression unless repugnant to the context or meaning hereof shall include its successors or assigns of the ONE PART

and

_____, (description of the party along with address), hereinafter referred to as "The Bidder/ Contractor" which expression unless repugnant to the context or meaning hereof shall include its successors or assigns of the OTHER PART

Preamble

The Principal intends to award, under laid-down organizational procedures, contract/s for _____

_____ (hereinafter referred to as "Contract"). The Principal values full compliance with all relevant laws of the land, rules and regulations, and the principles of economic use of resources, and of fairness and transparency in its relations with its Bidder(s)/ Contractor(s).

In order to achieve these goals, the Principal will appoint panel of Independent External Monitor(s) (IEMs), who will monitor the tender process and the execution of the contract for compliance with the principles mentioned above.

Section 1- Commitments of the Principal

- 1.1 The Principal commits itself to take all measures necessary to prevent corruption and to observe the following principles: -
 - 1.1.1 No employee of the Principal, personally or through family members, will in connection with the tender for, or the execution of a contract, demand, take a promise for or accept, for self or third person, any material or immaterial benefit which the person is not legally entitled to.
 - 1.1.2 The Principal will, during the tender process treat all Bidder(s) with equity and reason. The Principal will in particular, before and during the tender process, provide to all Bidder(s) the same information and will not provide to any Bidder(s) confidential/ additional information through which the Bidder(s) could obtain an advantage in relation to the tender process or the contract execution.
 - 1.1.3 The Principal will exclude from the process all known prejudiced persons.
- 1.2 If the Principal obtains information on the conduct of any of its employees which is a penal offence under the Indian Penal Code 1860 and Prevention of Corruption Act 1988 or any other statutory penal enactment, or if there be a substantive suspicion in this regard, the Principal will inform its Vigilance Office and in addition can initiate disciplinary actions.

Section 2 - Commitments of the Bidder(s)/ Contractor(s)

- 2.1 The Bidder(s)/ Contractor(s) commit himself to take all measures necessary to prevent corruption. The Bidder(s)/ Contractor(s) commits himself to observe the following principles during participation in the tender process and during the contract execution.

- 2.1.1 The Bidder(s)/ Contractor(s) will not, directly or through any other person or firm, offer, promise or give to the Principal or to any of the Principal's employees involved in the tender process or the execution of the contract or to any third person any material, immaterial or any other benefit which he/ she is not legally entitled to, in order to obtain in exchange any advantage of any kind whatsoever during the tender process or during the execution of the contract.
- 2.1.2 The Bidder(s)/ Contractor(s) will not enter with other Bidder(s) into any illegal or undisclosed agreement or understanding, whether formal or informal. This applies in particular to prices, specifications, certifications, subsidiary contracts, submission or non-submission of bids or any other actions to restrict competitiveness or to introduce cartelization in the bidding process.
- 2.1.3 The Bidder(s)/ Contractor(s) will not commit any penal offence under the relevant Indian Penal Code (IPC) and Prevention of Corruption Act; further the Bidder(s)/ Contractor(s) will not use improperly, for purposes of competition or personal gain, or pass on to others, any information or document provided by the Principal as part of the business relationship, regarding plans, technical proposals and business details, including information contained or transmitted electronically.
- 2.1.4 Foreign Bidder(s)/ Contractor(s) shall disclose the name and address of agents and representatives in India and Indian Bidder(s)/ Contractor(s) to disclose their foreign principals or associates. The Bidder(s)/ Contractor(s) will, when presenting his bid, disclose any and all payments he has made, and is committed to or intends to make to agents, brokers or any other intermediaries in connection with the award of the contract.
- 2.2 The Bidder(s)/ Contractor(s) will not instigate third persons to commit offences outlined above or be an accessory to such offences.
- 2.3 The Bidder(s)/ Contractor(s) shall not approach the Courts while representing the matters to IEMs and shall await their decision in the matter.

Section 3 - Disqualification from tender process and exclusion from future contracts

If the Bidder(s)/ Contractor(s), before award or during execution has committed a transgression through a violation of Section 2 above, or acts in any other manner such as to put his reliability or credibility in question, the Principal is entitled to disqualify the Bidder(s)/ Contractor(s) from the tender process, terminate the contract, if already awarded, exclude from future business dealings and/ or take action as per the separate "Guidelines on Banning of Business dealings with Suppliers/ Contractors", framed by the Principal.

Section 4 - Compensation for Damages

- 4.1 If the Principal has disqualified the Bidder (s) from the tender process before award / order acceptance according to Section 3, the Principal is entitled to demand and recover the damages equivalent to Earnest Money Deposit/ Bid Security.
- 4.2 If the Principal is entitled to terminate the Contract according to Section 3, or terminates the Contract in application of Section 3 above, the Bidder(s)/ Contractor (s) transgression through a violation of Section 2 above shall be construed breach of contract and the Principal shall be entitled to demand and recover from the Contractor an amount equal to 5% of the contract value or the amount equivalent to Security Deposit/ Performance Bank Guarantee, whichever is higher, as damages, in addition to and without prejudice to its right to demand and recover compensation for any other loss or damages specified elsewhere in the contract.

Section 5 - Previous Transgression

- 5.1 The Bidder declares that no previous transgressions occurred in the last 3 (three) years with any other company in any country conforming to the anti-corruption approach or with any other Public Sector Enterprise in India that could justify his exclusion from the tender process.
- 5.2 If the Bidder makes incorrect statement on this subject, he can be disqualified from the tender process or the contract, if already awarded, can be terminated for such reason or action can be taken as per the separate "Guidelines on Banning of Business dealings with Suppliers/ Contractors", framed by the Principal.

Section 6 - Equal treatment of all Bidder (s)/ Contractor (s) / Sub-contractor (s)

- 6.1 The Principal will enter into Integrity Pacts with identical conditions as this Integrity Pact with all Bidders and Contractors.
- 6.2 In case of Sub-contracting, the Principal Contractor shall take the responsibility of the adoption of Integrity Pact by the Sub-contractor(s) and ensure that all Sub-contractors also sign the Integrity Pact.
- 6.3 The Principal will disqualify from the tender process all Bidders who do not sign this Integrity Pact or violate its provisions.

Section 7 - Criminal Charges against violating Bidders/ Contractors /Subcontractors

If the Principal obtains knowledge of conduct of a Bidder, Contractor or Subcontractor, or of an employee or a representative or an associate of a Bidder, Contractor or Subcontractor which constitutes corruption, or if the Principal has substantive suspicion in this regard, the Principal will inform the Vigilance Office.

Section 8 -Independent External Monitor(s)

- 8.1 The Principal appoints competent and credible panel of Independent External Monitor (s) (IEMs) for this Integrity Pact. The task of the IEMs is to review independently and objectively, whether and to what extent the parties comply with the obligations under this Integrity Pact.
- 8.2 The IEMs are not subject to instructions by the representatives of the parties and performs his functions neutrally and independently. He reports to the CMD, BHEL.
- 8.3 The IEMs shall be provided access to all documents/ records pertaining to the Contract, for which a complaint or issue is raised before them as and when warranted. However, the documents/records/information having National Security implications and those documents which have been classified as Secret/Top Secret are not to be disclosed.
- 8.4 The Principal will provide to the IEMs sufficient information about all meetings among the parties related to the Contract provided such meetings could have an impact on the contractual relations between the Principal and the Contractor. The parties offer to the IEMs the option to participate in such meetings.

- 8.5 The advisory role of IEMs is envisaged as that of a friend, philosopher and guide. The advice of IEMs would not be legally binding and it is restricted to resolving issues raised by a Bidder regarding any aspect of the tender which allegedly restricts competition or bias towards some Bidders. At the same time, it must be understood that IEMs are not consultants to the Management. Their role is independent in nature and the advice once tendered would not be subject to review at the request of the organization.
- 8.6 For ensuring the desired transparency and objectivity in dealing with the complaints arising out of any tendering process or during execution of Contract, the matter should be examined by the full panel of IEMs jointly, who would look into the records, conduct an investigation, and submit their joint recommendations to the Management.
- 8.7 The IEMs would examine all complaints received by them and give their recommendations/ views to the CMD, BHEL at the earliest. They may also send their report directly to the CVO, in case of suspicion of serious irregularities requiring legal/ administrative action. Only in case of very serious issue having a specific, verifiable Vigilance angle, the matter should be reported directly to the Commission. IEMs will tender their advice on the complaints within 30 days.
- 8.8 The CMD, BHEL shall decide the compensation to be paid to the IEMs and its terms and conditions.
- 8.9 IEMs should examine the process integrity, they are not expected to concern themselves with fixing of responsibility of officers. Complaints alleging mala fide on the part of any officer of the Principal should be looked into by the CVO of the Principal.
- 8.10 If the IEMs have reported to the CMD, BHEL, a substantiated suspicion of an offence under relevant Indian Penal Code / Prevention of Corruption Act, and the CMD, BHEL has not, within reasonable time, taken visible action to proceed against such offence or reported it to the Vigilance Office, the IEMs may also transmit this information directly to the Central Vigilance Commissioner, Government of India.
- 8.11 After award of work, the IEMs shall look into any issue relating to execution of Contract, if specifically raised before them. As an illustrative example, if a Contractor who has been awarded the Contract, during the execution of Contract, raises issue of delayed payment etc. before the IEMs, the same shall be examined by the panel of IEMs. Issues like warranty/ guarantee etc. shall be outside the purview of IEMs.
- 8.12 However, the IEMs may suggest systemic improvements to the management of the Principal, if considered necessary, to bring about transparency, equity and fairness in the system of procurement.
- 8.13 The word 'Monitor' would include both singular and plural.

Section 9 - Pact Duration

- 9.1 This Integrity Pact shall be operative from the date this Integrity Pact is signed by both the parties till the final completion of contract for successful Bidder, and for all other Bidders 6 months after the Contract has been awarded. Any violation of the same would entail disqualification of the bidders and exclusion from future business dealings.
- 9.2 If any claim is made/ lodged during currency of this Integrity Pact, the same shall be binding and continue to be valid despite the lapse of this Pact as specified above, unless it is discharged/ determined by the CMD, BHEL.

Section 10 - Other Provisions

- 10.1 This Integrity Pact is subject to Indian Laws and exclusive jurisdiction shall be of the competent Courts as indicated in the Tender or Contract, as the case may be.
- 10.2 Changes and supplements as well as termination notices need to be made in writing.
- 10.3 If the Bidder(s)/ Contractor(s) is a partnership or a consortium or a joint venture, this Integrity Pact shall be signed by all partners of the partnership or joint venture or all consortium members.
- 10.4 Should one or several provisions of this Integrity Pact turn out to be invalid, the remainder of this Integrity Pact remains valid. In this case, the parties will strive to come to an agreement to their original intentions.
- 10.5 Only those bidders / contractors who have entered into this Integrity Pact with the Principal would be competent to participate in the bidding. In other words, entering into this Integrity Pact would be a preliminary qualification.
- 10.6 In the event of any dispute between the Principal and Bidder(s)/ Contractor(s) relating to the Contract, in case, both the parties are agreeable, they may try to settle dispute through Mediation before the panel of IEMs in a time bound manner. In case, the dispute remains unresolved even after mediation by the panel of IEMs, either party may take further action as the terms & conditions of the Contract. The fees/expenses on dispute resolution through mediation shall be shared by both the parties. Further, the mediation proceedings shall be confidential in nature and the parties shall keep confidential all matters relating to the mediation proceedings including any settlement agreement arrived at between the parties as outcome of mediation. Any views expressed, suggestions, admissions or proposals etc. made by either party in the course of mediation shall not be relied upon or introduced as evidence in any further arbitral or judicial proceedings, whether or not such proceedings relate to the dispute that is the subject of mediation proceedings. Neither of the parties shall present IEMs as witness in any Alternative Dispute Resolution or judicial proceedings in respect of the dispute that was subject of mediation.

 For & On behalf of the Principal
 (Office Seal)

 For & On behalf of the Bidder/ Contractor
 (Office Seal)

Place _____
 Date _____

Witness: _____
 (Name & Address) _____

Witness: _____
 (Name & Address) _____

Guidelines for Indian Agents of Foreign Suppliers

- 1.0 There shall be compulsory registration of agents for all Global (Open) Tender and Limited Tender. An agent who is not registered with BHEL shall apply for registration in the registration form in line with SEARP.
- 1.1 Registered agents will file an authenticated Photostat copy duly attested by a Notary Public/Original certificate of the Principal confirming the agency agreement and giving the status being enjoyed by the agent and the commission/ remuneration/ salary/ retainership being paid by the principal to the agent before the placement of order by BHEL.
- 1.2 Wherever the Indian representatives have communicated on behalf of their principals and the foreign parties have stated that they are not paying any commission to the Indian agents, and the Indian representative is working on the basis of salary or as retainer, a written declaration to this effect should be submitted by the party (i.e. Principal) before finalizing the order.
- 2.0 Disclosure of particulars of agents/ representatives in India, if any.**
- 2.1 Tenderers of Foreign nationality shall furnish the following details in their offers:
- 2.1.1 The Bidder(s)/ Contractor(s) of foreign origin shall disclose the name and address of the agents/ representatives in India if any and the extent of authorization and authority given to commit the Principals. In case the agent/ representative be a foreign Company, it shall be confirmed whether it is existing Company and details of the same shall be furnished.
- 2.1.2 The amount of commission/ remuneration included in the quoted price(s) for such agents/ representatives in India.
- 2.1.3 Confirmation of the Tenderer that the commission/ remuneration, if any, payable to his agents/ representatives in India, may be paid by BHEL in Indian Rupees only.
- 2.2 Tenderers of Indian Nationality shall furnish the following details in their offers:
- 2.2.1 The Bidder(s)/ Contractor(s) of Indian Nationality shall furnish the name and address of the foreign principals, if any, indicating their nationality as well as their status, i.e. whether manufacturer or agents of manufacturer holding the Letter of Authority of the Principal specifically authorizing the agent to make an offer in India in response to tender either directly or through the agents/ representatives.
- 2.2.2 The amount of commission/ remuneration included in the price (s) quoted by the Tenderer for himself.
- 2.2.3 Confirmation of the foreign principals of the Tenderer that the commission/ remuneration, if any, reserved for the Tenderer in the quoted price(s), may be paid by BHEL in India in equivalent Indian Rupees on satisfactory completion of the Project or supplies of Stores and Spares in case of operation items.
- 2.3 In either case, in the event of contract materializing, the terms of payment will provide for payment of the commission/ remuneration, if any payable to the agents/ representatives in India in Indian Rupees on expiry of 90 days after the discharge of the obligations under the contract.
- 2.4 Failure to furnish correct and detailed information as called for in paragraph 2.0 above will render the concerned tender liable to rejection or in the event of a contract materializing, the same liable to termination by BHEL. Besides this there would be a penalty of banning business dealings with BHEL or damage or payment of a named sum.

Annexure-B

This format is applicable only to Indian Suppliers/ Agents supplying indigenous portion of Foreign Purchases.

* In all other cases, extant guidelines of SEARP, 2010 are to be followed.

SEARP (SRF) Clause No	Detail
	Name & address of the firm
1.0	Products/ Systems / Services being considered for
2.0	General Information
2.2	Name of Chief Executive
2.3	Details of authorized signatory
3.0	Ownership Information
3.1	Type of firm
3.2	Nature of Business <ul style="list-style-type: none"> • Attach authorization letter and agency agreement from Principal (from whom capital equipment is procured) • Attach copy of declaration from Foreign Principal for total guarantee/ warranty of indigenous supplies
3.3	Year of establishment
3.4	Year of commencement of business
4.0	Registration particulars
4.1	Permanent Account No.
4.2 / 4.3	Sales Tax / TIN no
4.6	Service tax no. (in case of E&C)
5.0	Organisational strength
6.0	Other particulars
6.1	If the company is already registered with other units
6.2	Directors/ Partners, if related to any BHEL Employee
6.9	If any Ex BHEL Personnel employed by the Company
6.12	Details of pending legal issues with BHEL
6.13	Bank Account information
9.0	Financial information
9.6	Sales/ Turnover details of last 3 years (or from the date of incorporation whichever is less)

Guidelines for Reverse Auction – 2021

Doc. No. AA:SSP:RA:05
Dated: 08.03.2021

Business Rules for Reverse Auction

Annexure – I

This has reference to tender no **{tender number....date...}**. BHEL shall finalise the Rates for the supply of *{item name}* through Reverse Auction mode. BHEL has made arrangement with M/s. *{Service provider}*, who shall be BHEL's authorized service provider for the same. Bidders should go through the instructions given below and submit acceptance of the same.

The technical & commercial terms are as per (a) BHEL Tender Enq. No. {...} dated {...}, (b) Bidders' technical & commercial bid (in case of two part bid) and (c) subsequent correspondences between BHEL and the bidders, if any.

1. Procedure of Reverse Auctioning

- i. Price bids of all techno-commercially qualified bidders shall be opened.
- ii. **Reverse Auction:** The 'bid decrement' will be decided by BHEL.
- iii. The lowest bidder in sealed envelope price bid shall be shown as current L1 automatically by the system and no acceptance of that price is required. System shall have the provision to indicate this bid as current L1.
- iv. Bidders by offering a minimum bid decrement or the multiples thereof can displace a standing lowest bid and become "L1" and this continues as an iterative process. However, no bidder shall be allowed to lower its bid below the current L1 by more than 5 decrements at one go.
- v. After the completion of the reverse auction, the Closing Price shall be available for further processing.
- vi. Wherever the evaluation is done on total cost basis, after Reverse Auction, prices of individual line items shall be reduced on pro-rata basis.

2. Schedule for reverse auction: The Reverse Auction is tentatively scheduled on *{date}*: *;**{start time}*: *;**{Close Time}*: *}*.

3. Auction extension time: If a bidder places a bid in the last {...} minutes of closing of the Reverse Auction and if that bid gets accepted, then the auction's duration shall get extended automatically for another {...} minutes,

Guidelines for Reverse Auction – 2021

Doc. No. AA:SSP:RA:05

Dated: 08.03.2021

Business Rules for Reverse Auction

Annexure – I

for the entire auction (i.e. for all the items in the auction), from the time that bid comes in. Please note that the auto-extension will take place only if a bid comes in those last {...} minutes and if that bid gets accepted as the lowest bid. If the bid does not get accepted as the lowest bid, the auto-extension will not take place even if that bid might have come in the last {...} minutes. In case, there is no bid in the last {...} minutes of closing of Reverse Auction, the auction shall get closed automatically without any extension. However, bidders are advised not to wait till the last minute or last few seconds to enter their bid during the auto-extension period to avoid complications related with internet connectivity, network problems, system crash down, power failure, etc.

The above process will continue till completion of Reverse Auction.

Complaints/ Grievances, if any, regarding denial of service or any related issue should be given in writing thru e-mail/ fax to M/s. {Service provider} with a copy to BHEL within 15 minutes prior to initial closing time of Reverse Auction.

4. **Bid price:** The Bidder has to quote the {...} Price inclusive of Packing & Forwarding charges, all the routine & type tests as per tender scope, taxes, duties, freight and insurance as specified in tender document, including loading (if indicated by BHEL due to deviations in technical/ commercial terms) for the Items specified. Details are as shown in Excel Sheet for calculation of total cost to BHEL (To be specified by Unit as per NIT conditions).
5. **Bidding currency and unit of measurement:** Bidding will be conducted in *Indian Rupees per Unit* of the material as per the specifications {...}

In case of foreign currency bids, exchange rate (TT selling rate of State Bank of India) as on scheduled date of tender opening (Part-I bid) shall be considered for conversion in Indian Rupees. If the relevant day happens to be a Bank holiday, then the forex rate as on the previous bank (SBI) working day shall be taken.

6. **Validity of bids:** Price shall be valid for {... days} from the date of reverse auction. These shall not be subjected to any change whatsoever.

Guidelines for Reverse Auction – 2021

Doc. No. AA:SSP:RA:05
Dated: 08.03.2021

Business Rules for Reverse Auction

Annexure – I

-
7. **Lowest bid of a bidder:** In case the bidder submits more than one bid, the lowest bid at the end of Reverse Auction will be considered as the bidder's final offer to execute the work.
 8. Unique user IDs shall be used by bidders during bidding process. All bids made from the Login ID given to the bidders will be deemed to have been made by the bidders/ bidders' company.
 9. **Post auction procedure:** BHEL will proceed with the Lowest Bid in the Reverse Auction for further processing.
 10. Any commercial/ technical loading shall be separately intimated to respective bidders prior to RA. The excel sheet provided in this regard shall cover all these aspects. Commercial/ technical loading if any, shall be added by the respective bidder in its price during Reverse Auction. Modalities of loading & de-loading shall be separately intimated to the bidders. The responsibility for correctness of total cost to BHEL shall lie with the bidders.
 11. Reverse auction shall be conducted by BHEL (through M/s {Service Provider}), on pre-specified date, while the bidders shall be quoting from their own offices/ place of their choice. Internet connectivity shall have to be ensured by bidders themselves.

During the RA process if a bidder is not able to bid and requests for extension of time by FAX/ email/ phone then time extension of additional 15 minutes will be given by the service provider provided such requests come before 5 minutes of auction closing time. However, only one such request per bidder can be entertained.

In order to ward-off contingent situation of connectivity failure bidders are requested to make all the necessary arrangements/ alternatives whatever required so that they are able to circumvent such situation and still be able to participate in the reverse auction successfully. Failure of power or loss of connectivity at the premises of bidders during the Reverse auction cannot be the cause for not participating in the reverse auction. On account of this, the time for the auction cannot be extended and neither BHEL nor M/s. {Service provider} is responsible for such eventualities.

Guidelines for Reverse Auction – 2021

Doc. No. AA:SSP:RA:05

Dated: 08.03.2021

Business Rules for Reverse Auction

Annexure – I

-
- 12.** Proxy bids: Proxy bidding feature is a pro-bidder feature to safe guard the bidder's interest of any internet failure or to avoid last minute rush. The proxy feature allows bidders to place an automated bid in the system directly in an auction and bid without having to enter a new amount each time a competing bidder submits a new offer. The bid amount that a bidder enters is the minimum that the bidder is willing to offer. Here the software bids on behalf of the bidder. This obviates the need for the bidder participating in the bidding process until the proxy bid amount is decrementally reached by other bidders. When proxy bid amount is reached, the bidder (who has submitted the proxy bid) has an option to start participating in the bidding process.

The proxy amount is the minimum amount that the bidder is willing to offer. During the course of bidding, the bidder cannot delete or change the amount of a proxy bid.

Bids are submitted in decrements (decreasing bid amounts). The application automates proxy bidding by processing proxy bids automatically, according to the decrement that the auction originator originally established when creating the auction, submitting offers to the next bid decrement each time a competing bidder bids, regardless of the fact whether the competing bids are submitted as proxy or standard bids. However, it may please be noted that if a manual bid and proxy bid are submitted at the same instant manual bid will be recognized as the L1 at that instant.

In case of more than one proxy bid, the system shall bid till it crosses the threshold value of 'each lowest proxy bid' and thereafter allow the competition to decide the final L1 price.

Proxy bids are fed into the system directly by the respective bidders. As such this information is privy only to the respective bidder(s).

- 13.** Bidders are advised to get fully trained and clear all their doubts such as refreshing of Screen, quantity being auctioned, tender value being auctioned etc from M/s {Service provider}.
- 14.** M/s. {Service provider}, shall arrange to demonstrate/ train the bidder or bidder's nominated person(s), without any cost to bidders. M/s. {Service provider}, shall also explain the bidders, all the business rules related to the
-

Guidelines for Reverse Auction – 2021

Doc. No. AA:SSP:RA:05

Dated: 08.03.2021

Business Rules for Reverse Auction

Annexure – I

Reverse Auction. Bidders are required to submit their acceptance to the terms/ conditions/ modalities before participating in the Reverse Auction in the process compliance form as enclosed. Without this, the bidder will not be eligible to participate in the event.

15. Successful bidder shall be required to submit the final prices (L1) in prescribed format (Annexure – VI) for price breakup, quoted during the Reverse Auction, duly signed and stamped as token of acceptance without any new condition (other than those already agreed to before start of auction), after the completion of auction to M/s. {Service provider} besides BHEL within two working days of Auction without fail.
16. Any variation between the final bid value and that in the confirmatory signed price breakup document will be considered as tampering the tender process and will invite action by BHEL as per extant guidelines for suspension of business dealings (as available on www.bhel.com).
17. Bidders' bid will be taken as an offer to execute the work/ supplies the item as per enquiry no. {...} dt. {...}. Bids once made by the bidder, cannot be cancelled/ withdrawn and bidder shall be bound to execute the work as mentioned above at bidder's final bid price. Should bidder back out and not execute the contract as per the rates quoted, BHEL shall take action as per extant guidelines for suspension of business dealings (as available on www.bhel.com).
18. Bidders shall be able to view the following on their screen along with the necessary fields during Reverse Auction:
 - a. Leading (Running Lowest) Bid in the Auction (only total price of package)
 - b. Bid Placed by the bidder
 - c. Start Price
 - d. Decrement value
 - e. Rank of their own bid during bidding as well as at the close of auction.
19. BHEL's decision on award of contract shall be final and binding on all the Bidders.
20. BHEL reserves the right to extend, reschedule or cancel the Reverse Auction process at any time, before ordering, without assigning any reason, with

Guidelines for Reverse Auction – 2021

Doc. No. AA:SSP:RA:05
Dated: 08.03.2021

Business Rules for Reverse Auction

Annexure – I

intimation to bidders.

21. BHEL shall not have any liability to bidders for any interruption or delay in access to the site irrespective of the cause. In such cases, the decision of BHEL shall be binding on the bidders.
22. Other terms and conditions shall be as per bidder's techno-commercial offers and other correspondences, if any, till date.
23. If there is any clash between this business document and the FAQ available, if any, in the website of M/s. {*Service provider*}, the terms & conditions given in this business document will supersede the information contained in the FAQs. Any changes made by BHEL/ service provider (due to unforeseen contingencies) after the first posting shall be deemed to have been accepted if the bidder continues to access the portal after that time.
24. Bidder shall not divulge either his Bids or any other exclusive details of BHEL to any other party. If the Bidder or any of his representatives are found to be involved in Price manipulation/ cartel formation of any kind, directly or indirectly by communicating with other bidders, action as per extant BHEL guidelines for suspension of business dealings (as available on www.bhel.com), shall be initiated by BHEL.

Guidelines for Reverse Auction – 2021

Doc. No. AA:SSP:RA:05
Dated: 08.03.2021

Mandate to Service Provider

Annexure – II

Ref :

Date :

To,

M/s. {Service provider}

Sub: Providing of Services for Reverse Auction.

Ref: No {...} date {...}

Dear Sir,

Please conduct Reverse Auction as per the following details:

- **Scope:** Auction event management with training of BHEL and its bidders.
- Seek process compliance form from all the bidders provided by BHEL before start of RA event. In case of postponement of event to some other date, ensure acknowledgement from each bidder.
- Price: Rs. {.....}/- . No other duties, Taxes, levies etc. except service tax @ {.....}% shall be payable for conducting reverse auction. This price is firm.
- Payment Terms: 100% payment after successful completion of Auction.
- Start Price: L1 as per the CST (Comparative statement) of the envelope sealed bid shall be marked as L1 automatically by the system at the start of the auction, provided the L1 bidder participates in the RA by submitting the process compliance form. In case the Process Compliance form is not submitted by the L1 bidder, still its price has to be mapped as start price of RA for further bidding in RA.

Wherever there are more than one L1 in CST, the start price shall be the L1 price reduced by one decrement and the same shall be accepted by the interested bidder(s) for start of RA process.

- Completion of Auction Process: The auction process shall be deemed to have been successfully completed on receipt and acceptance of final report including hard copy/ email of the final bid with price break up, duly signed by the successful bidder who has participated in the reverse auction. The bill shall be submitted along with the completion report to the undersigned.
- Business Rules of the Reverse Auction are as per Annexure – I.
- The list of bidders with their contact details is given in Annexure – IV. and the details of the item (s) to be Reverse Auctioned are as per Annexure – V.
- Please acknowledge receipt of this letter order and also confirm that final report (duly signed and stamped by M/s. {Service provider}) including hard copy/ email of the final bid with breakup of prices duly signed by the successful bidder (duly endorsed by M/s. {Service provider}) shall be submitted within **four** working days of conclusion of auction.

Yours sincerely,

(for and on behalf of BHEL)

Guidelines for Reverse Auction – 2021

Doc. No. AA:SSP:RA:05
Dated: 08.03.2021

Mandate to Service Provider

Annexure – II

Note:

If the event has been conducted as per mandate, you shall be paid irrespective of RA outcome.

Buyer Name	<ul style="list-style-type: none">- Name of BHEL Unit- Full postal address- Fax:- Phone:- Email:- Contact person name:- Phone:-
Auction to be conducted by	<ul style="list-style-type: none">- Name of Service provider- Full postal address- Fax:- Phone:- Email:- Contact person name:- Phone:-
Date of Auction	<ul style="list-style-type: none">- Date of Auction- Reverse auction time:- Auction website:-
Documents Attached: (To be sent to the bidders)	<ol style="list-style-type: none">1) Business rules for Reverse Auction (<u>Annexure-I</u>)2) Process Compliance Form (<u>Annexure-III</u>)3) Details of item (s) to be Reverse Auctioned (<u>Annexure-V</u>)4) Post RA Price confirmation by bidder (<u>Annexure-VI</u>)

Guidelines for Reverse Auction – 2021

Doc. No. AA:SSP:RA:05

Dated: 08.03.2021

Process Compliance Form

Annexure – III

(The bidders are required to print this on their company's letterhead and sign, stamp before RA)

To

- M/s. {Service provider}
- Postal address}

Sub: Agreement to the Process related Terms and Conditions

Dear Sir,

This has reference to the Terms & Conditions for the Reverse Auction mentioned in the RFQ document for {Items} against BHEL enquiry/ RFQ no.{.....} dt. {.....} This letter is to confirm that:

- 1) The undersigned is authorized official/ representative of the company to participate in RA and to sign the related documents.
- 2) We have studied the Reverse Auction guidelines (as available on www.bhel.com), and the Business rules governing the Reverse Auction as mentioned in your letter and confirm our agreement to them.
- 3) We also confirm that we have taken the training on the auction tool and have understood the functionality of the same thoroughly.
- 4) We also confirm that, in case we become L1 bidder, we will FAX/ email the price confirmation & break up of our quoted price as per Annexure - VI within **two** working days (of BHEL) after completion of RA event, besides sending the same by registered post/ courier both to M/s. BHEL and M/s. {Service provider.}

We, hereby confirm that we will honor the Bids placed by us during the auction process.

With regards

Signature with company seal

Name –

Company / Organization

Designation within Company / Organization

Address of Company / Organization

- **Sign this document and FAX/ email it to M/s {Service provider} at {.....} prior to start of the Event.**

Guidelines for Reverse Auction – 2021

Doc. No. AA:SSP:RA:05

Dated: 08.03.2021

List of bidders and their address/ contact person details

Annexure – IV

Sl. No.	Address	Contact Person
1	<ul style="list-style-type: none">- Name of bidder- Full postal address- Fax:- Phone:- Email:	<ul style="list-style-type: none">- Contact person name:- Phone:- Email:
2		
3		
..		
..		

Guidelines for Reverse Auction – 2021

Doc. No. AA:SSP:RA:05

Dated: 08.03.2021

Details of item (s) for Reverse Auction

Annexure – V

1. *{Details of items including quantity, specification, Enquiry no. & date*

1.

2.

..

..

..

}

Guidelines for Reverse Auction – 2021

Doc. No. AA:SSP:RA:05
Dated: 08.03.2021

RA price confirmation and breakup (To be submitted by L1 bidder after completion of RA)

Annexure – VI

To

- M/s. Service provider
- Postal address

CC: M/s BHEL
{Unit-
Address-}

Sub: **Final price quoted during Reverse Auction and price breakup**

Dear Sir,

We confirm that we have quoted.

**Rs. {___ in value & in words _____} for item(s) covered under tender enquiry
No. {...} dt. {...}**

Total price of the items covered under above cited enquiries is inclusive of {Packing & forwarding, GST, E.D., C.S.T., freight and insurance charges up to {.....} District, {.....} State and Type Test Charges etc., (exclusive of service tax), other as per NIT}

as our final landed prices as quoted during the Reverse Auction conducted today {date} which will be valid for a period of {___ in nos. & in words ___} days.

The price break-up is as given below.

Total =====
- Rs. **in value & in words**
=====

Yours sincerely,

For _____

Name:
Company:
Date:
Seal: